

## Fixed Slot Tenons · with cylindrical fastening

23110.0120



### Product Description

To be used for locating fixtures and clamping elements onto mounting pallets or pallets with cylindrical location holes. They can be inserted in holes as well as in slots.

### Material

- Steel, case-hardened, blackened, ground

### Drawing



### Order information

T-slot size machine b h6 [mm]	Dimensions d <sub>1</sub> [mm]	For screws ISO 4762		Art. No.
		(picture 1)	(picture 2)	
20	36	M6	M8	45
				<b>23110.0120</b>

### Application example

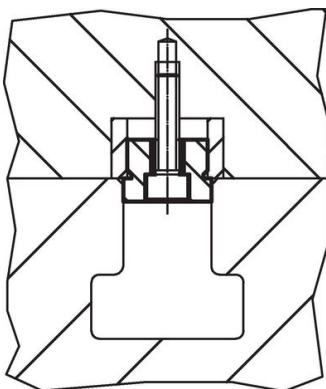

picture 1

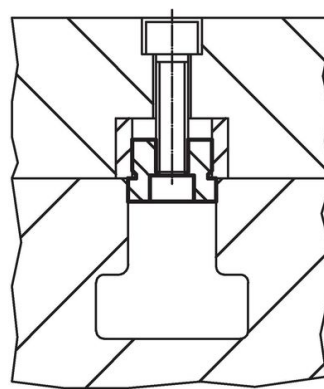

picture 2

## Compliance

### RoHS compliant

Compliant according to Directive 2011/65/EU and Directive 2015/863.

### Does not contain SVHC substances

No SVHC substances with more than 0.1% w/w contained - SVHC list [REACH] as of 27.06.2024.

### Does not contain Proposition 65 substances

No Proposition 65 substances included.

<https://www.P65Warnings.ca.gov/>

### Free from Conflict Minerals

This product does not contain any substances designated as "conflict minerals" such as tantalum, tin, gold or tungsten from the Democratic Republic of Congo or adjacent countries.