

## Fixed Slot Tenons

23110.0036



### Product Description

To be used for locating fixtures and clamping elements onto machine tables with T-slots to DIN 650.

### Material

- Steel, case-hardened, blackened, ground

### More information

### References

For size 20 refer to 23130.0020.

### Drawing

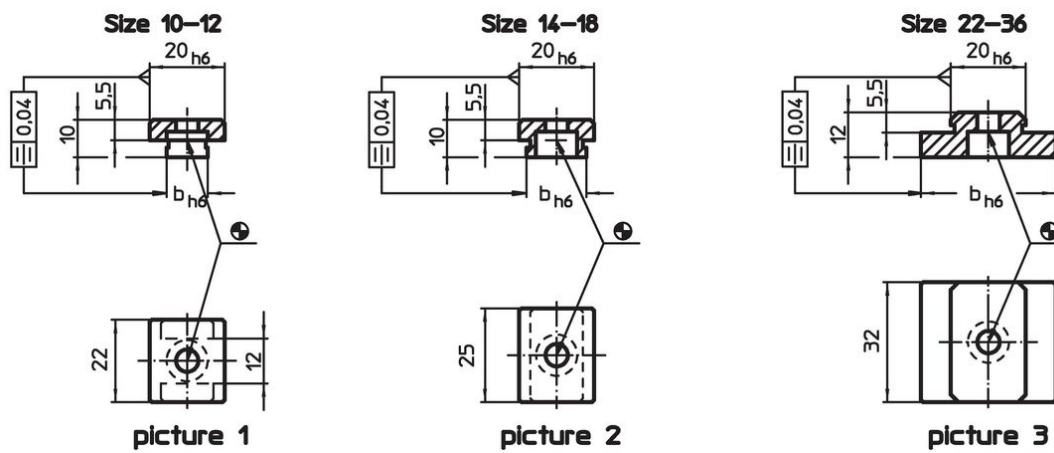

### Order information

T-slot size machine b h6 [mm]	For screws ISO 4762 [mm]	 [g]	Art. No.
size 22-36 – picture 3 36	M6	81	23110.0036

### Application example

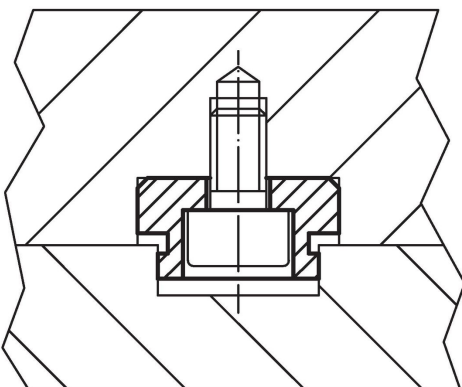

## Compliance

### RoHS compliant

Compliant according to Directive 2011/65/EU and Directive 2015/863.

### Does not contain SVHC substances

No SVHC substances with more than 0.1% w/w contained - SVHC list [REACH] as of 23.01.2024.

### Does not contain Proposition 65 substances

No Proposition 65 substances included.

<https://www.P65Warnings.ca.gov/>

### Free from Conflict Minerals

This product does not contain any substances designated as "conflict minerals" such as tantalum, tin, gold or tungsten from the Democratic Republic of Congo or adjacent countries.