

## Washers · high precision design

23060.0110



### Product Description

The precisely manufactured washers have an allowance in parallelism of 0,05 mm.

### Material

- Heat-treated steel, tempered, blackened

### Drawing

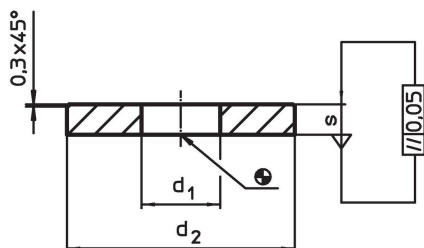

### Order information

d <sub>1</sub>	Dimensions		s	For screws	[g]	Art. No.
	d <sub>2</sub>	[mm]				
Heat-treated steel						
10.5	30		4	M10	19	23060.0110

### Application example

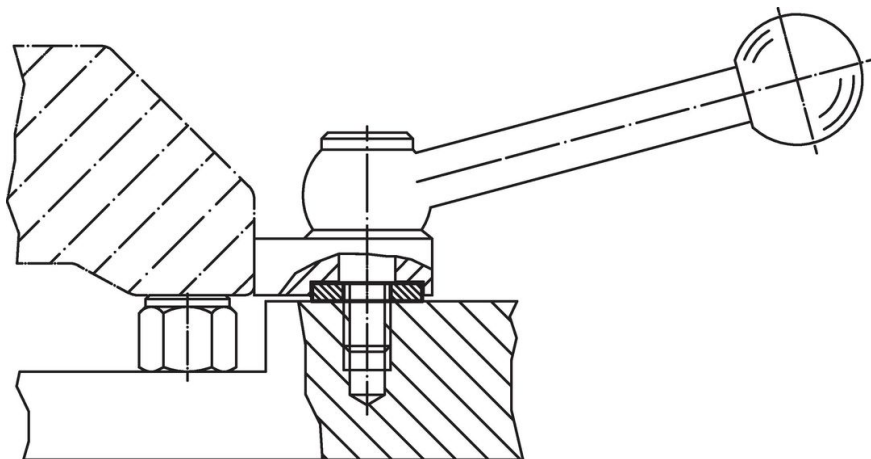

## Compliance

### RoHS compliant

Compliant according to Directive 2011/65/EU and Directive 2015/863.

### Does not contain SVHC substances

No SVHC substances with more than 0.1% w/w contained - SVHC list [REACH] as of 23.01.2024.

### Does not contain Proposition 65 substances

No Proposition 65 substances included.

<https://www.P65Warnings.ca.gov/>

### Free from Conflict Minerals

This product does not contain any substances designated as "conflict minerals" such as tantalum, tin, gold or tungsten from the Democratic Republic of Congo or adjacent countries.