

Compact Spherical Washers / Conical Seats • similar to DIN 6319

23050.0562



Product Description

The compact spherical washer / conical seat is a permanently fastened component of spherical washer and conical seat offering the following benefits:

- Function-safety,
- Secured against loss,
- Quick and rational assembly,
- Simplified stock holding,
- Swiveling range max. 4°.

Material

Conical seat

- Stainless steel 1.4305

Spherical washer

- Stainless steel 1.4305

Drawing

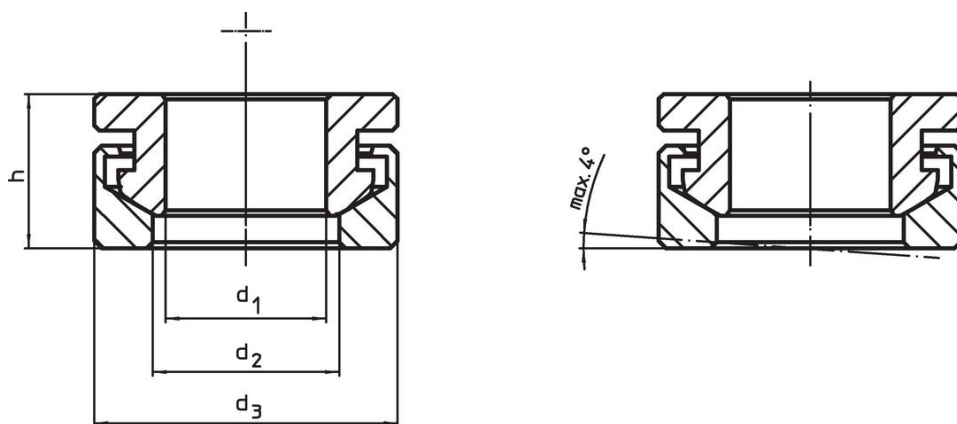

Order information

Dimensions				For pin	For screws	Load capacity	Torque for screwed connections ¹⁾	Art. No.
d ₁	d ₂	d ₃	h	d ₆	d ₆	for static load max.	max.	
[mm]				[mm]	[mm]	[kN]	[Nm]	[g]
H13								
13	14.8	25	13.1	12	M12	24	56	28

¹⁾ Torques of screws with standard thread, eventual pre-loads to be considered, coefficient of friction μ_{total} 0.14.

Application example

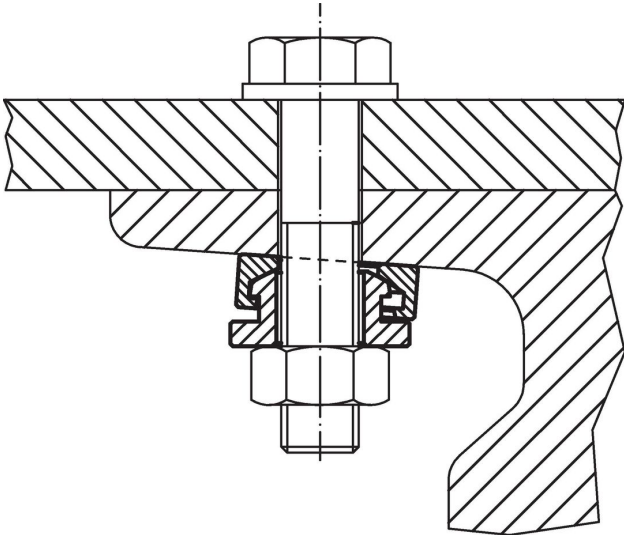

Compliance

RoHS compliant

Compliant according to Directive 2011/65/EU and Directive 2015/863.

Does not contain SVHC substances

No SVHC substances with more than 0.1% w/w contained - SVHC list [REACH] as of 23.01.2024.

Does not contain Proposition 65 substances

No Proposition 65 substances included.
<https://www.P65Warnings.ca.gov/>

Free from Conflict Minerals

This product does not contain any substances designated as "conflict minerals" such as tantalum, tin, gold or tungsten from the Democratic Republic of Congo or adjacent countries.