

Spherical Washers / Conical Seats • DIN 6319

23050.0148



Product Description

Spherical washers / Conical seats are used as washers in a screw connection to compensate non-parallel surfaces.

Material

Conical seat

- Case-hardened steel, case-hardened, manganese phosphated

Assembly

Conical seats form D are to be used only for plain, closed round areas.
For larger holes only use form G!

More information

Further products

- Spherical Washers / Conical Seats, similar to DIN 6319, stainless steel
- Fixture Nuts, DIN 6330 (height 1,5 d)

Drawing

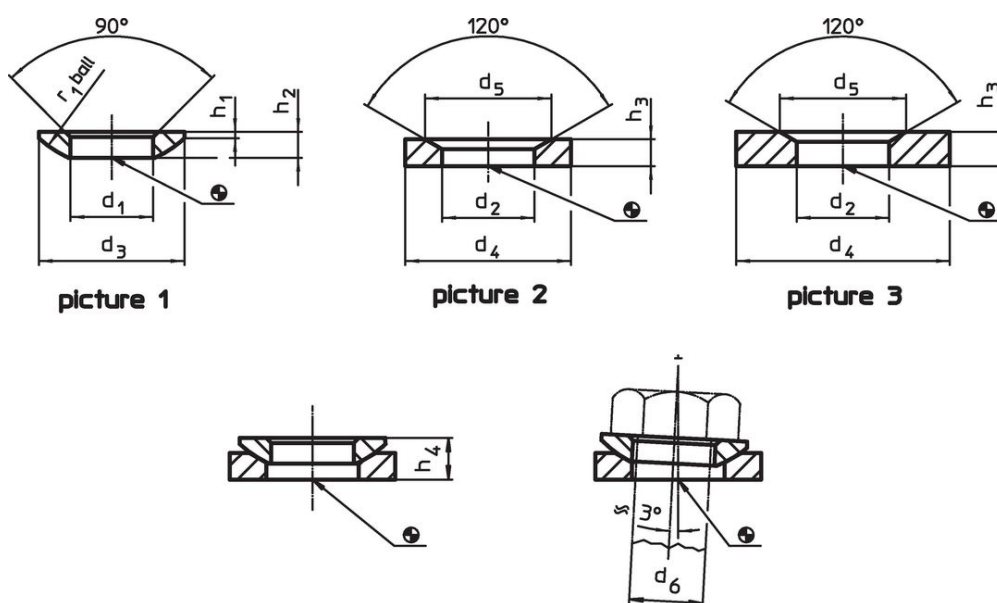

Order information

d ₂ H13	Dimensions			For pin d ₆ [mm]	For screws d ₆ [mm]	Load capacity for static load max. [kN]	Torque for screwed connections ¹⁾ max. [Nm]	Art. No.
	d ₄	d ₅	h ₃					
conical seats from case-hardened steel, form D – picture 2								
56	92	82	22	48	M48	714	5730	640 23050.0148

¹⁾ Torques of screws with standard thread, eventual pre-loads to be considered, coefficient of friction μ_{total} 0.14.

Application example



Compliance

RoHS compliant

Contains lead - compliant according to exceptions 6a / 6b / 6c.

Contains SVHC substances >0,1% w/w

Contains lead - SVHC list [REACH] as of 23.01.2024.

Contains Proposition 65 substances



Lead can cause cancer and reproductive harm from exposure
<https://www.P65Warnings.ca.gov/>

Free from Conflict Minerals

This product does not contain any substances designated as "conflict minerals" such as tantalum, tin, gold or tungsten from the Democratic Republic of Congo or adjacent countries.