

Studs • with internal hexagon, similar to DIN 6379, for nuts for T-Slots

23040.0783



Product Description

Studs combined with T-nuts DIN 508 (EH 23010./23020.), fixture nuts DIN 6330 (EH 23070.) and plain washers DIN 6340 (EH 23060.) become complete clamping studs. These studs are characterised by the rolled thread.

Material

- Heat-treated steel

Assembly

The stud has an internal hexagon additionally. This guarantees a fast and simple assembling and dismounting.

More information

References

For torques and strengths please refer to appendix - Technical Data -

Further products

- Nuts for T-Slots, DIN 508
- Studs, DIN 6379 for T-nuts
- Studs, DIN 6379 b_1 long for nut for T-Slots
- Shaft / Plain Washers, DIN 6340 heat-treated
- Fixture Nuts, DIN 6330 (height 1,5 d)

Drawing

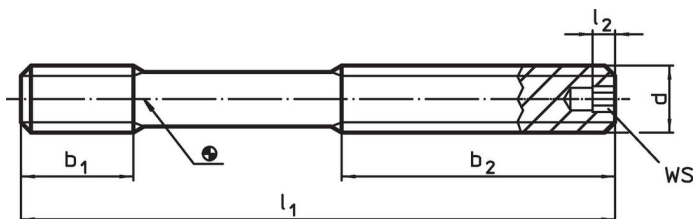

Order information

d	l_1	Dimensions			WS	Art. No.
		b_1	b_2	l_2		
quality 12.9						
[mm]	[mm]	[mm]	[mm]	[mm]	[mm]	[g]
M20	160	27	100	5	5	320
						23040.0783

Application example



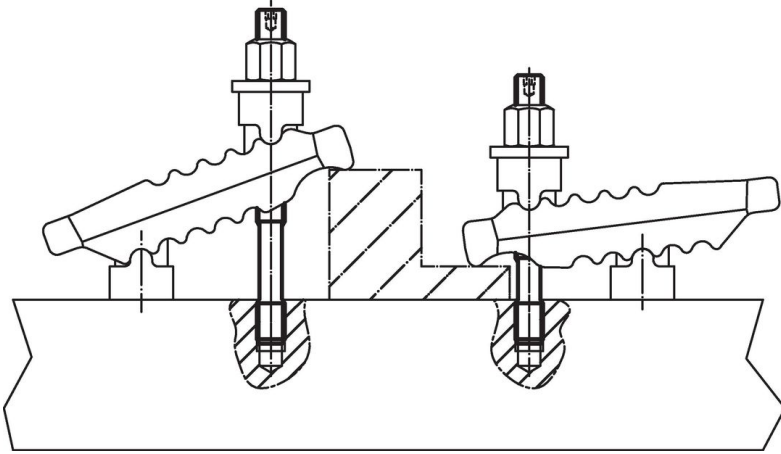

Compliance

RoHS compliant

Compliant according to Directive 2011/65/EU and Directive 2015/863.

Does not contain SVHC substances

No SVHC substances with more than 0.1% w/w contained - SVHC list [REACH] as of 23.01.2024.

Does not contain Proposition 65 substances

No Proposition 65 substances included.
<https://www.P65Warnings.ca.gov/>

Free from Conflict Minerals

This product does not contain any substances designated as "conflict minerals" such as tantalum, tin, gold or tungsten from the Democratic Republic of Congo or adjacent countries.