

Rod Ends · DIN 12240-4, with male thread

22982.0336



Product Description

Rod ends are suitable for universal use in applications subject to dynamic loads. As well as use in corrosion-risk areas, the design in stainless steel can also be used under higher dynamic loads. Rod ends are used for bearings where movements between shaft and housing are necessary, and where the movements are not in a straight line.

Rod ends are ready-to-install elements manufactured to DIN ISO 12240-4 (dimension series K). The PTFE fabric inserted into the bearing shell means that the rod ends are maintenance-free.

Please take note of the technical information which follows these product pages.

Material

Body

- Stainless steel 1.4057, forged, polished

Joint ball

- Stainless steel 1.4034, hardened, ground, polished

Bearing

- PTFE fabric

Bearing shell

- Stainless steel 1.4571

Drawing

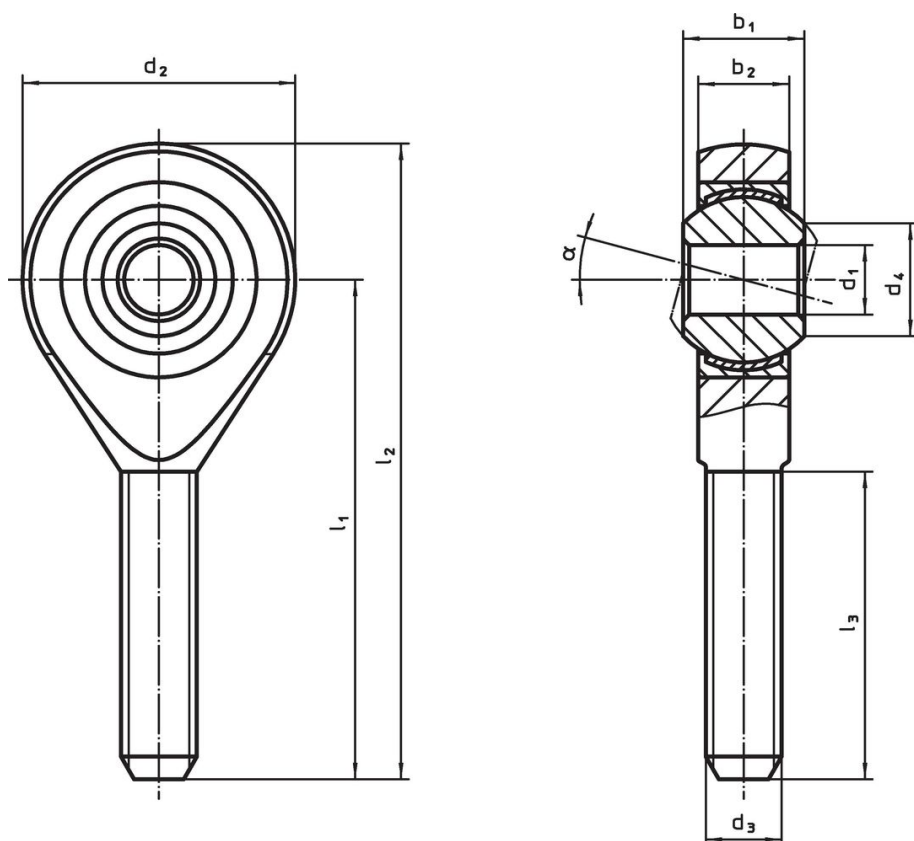

Order information

Dimensions										α	Dynamic carrying figure C [kN]	Static carrying figure C ₀ [kN]	Temperature		Weight [g]	Art. No.	
d ₁	l ₁	b ₁	b ₂	d ₂	d ₃	d ₄	l ₂	l ₃	min.				max.	[°C]			
left hand thread, Stainless steel																	
16	66	21	15	42	M16	19.3	87	40	15°	52.5	60.5	-50	150	202	22982.0336		

Compliance

RoHS compliant

Compliant according to Directive 2011/65/EU and Directive 2015/863.

Does not contain SVHC substances

No SVHC substances with more than 0.1% w/w contained - SVHC list [REACH] as of 23.01.2024.

Does not contain Proposition 65 substances

No Proposition 65 substances included.

<https://www.P65Warnings.ca.gov/>

Free from Conflict Minerals

This product does not contain any substances designated as "conflict minerals" such as tantalum, tin, gold or tungsten from the Democratic Republic of Congo or adjacent countries.