

Expander® Sealing Plugs · with elongated pull-anchor

22880.0417



Product Description

Expander® sealing plugs are used for safe, quick and economic sealing of bore holes in fluid technology, e.g. hydraulic drilling holes in jig and fixture construction. When using sealing plugs with elongated pull-anchor, assembly is made by means of user friendly assembly devices. Body and pin are pre-assembled and suitable for automated processing.

ATTENTION:

If Expander® sealing plugs with pull-anchor are applied to separate grooves, the admissible working pressure at the setting side has to be reduced by 50 %!

Please refer to the technical data following these product information pages.

Material

Body

- Case-hardened steel, annealed

Pin

- Steel

More information

Further products

- Distance Bushings, for Expander® sealing plugs with elongated pull-anchor
- Assembly Tools, for Expander® sealing plugs with pull-anchor

Drawing

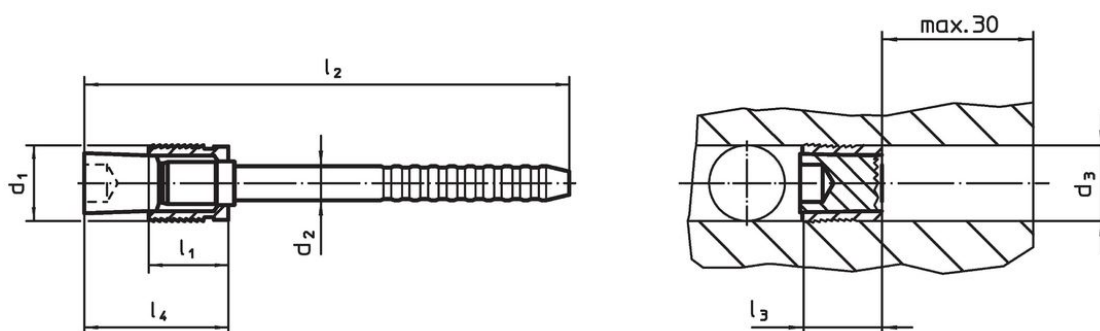

Order information

Dimensions							[g]	Art. No.
d ₁	d ₂	d ₃ +0.12 0	l ₁	l ₂	l ₃ max.	l ₄ max.		
7	4.1	7	7.5	68	9	14	7.9	22880.0417

Application example

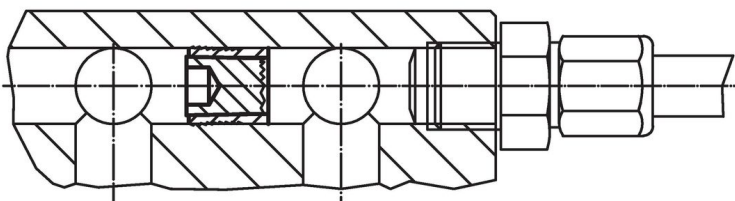

Working and control pressures for Expander® sealing plug with elongated pull-anchor

basic material	ETG-100 AISI 1144	C15Pb 1.0403	GG-25 DIN 1691	GGG-50 DIN 1693	AlCuMg2 3.1354	AlMgSiPb 3.0615	G-AISI7Mg 3.2371
d ₁ 4-10 mm	p [bar]						
	500	500	500	500	500	450	450
	pTest [bar]						
	1600	1600	1600	1600	1600	1400	1400

Compliance

RoHS compliant

Contains lead - compliant according to exceptions 6a / 6b / 6c.

Contains SVHC substances >0,1% w/w

Contains lead - SVHC list [REACH] as of 23.01.2024.

Contains Proposition 65 substances



Lead can cause cancer and reproductive harm from exposure
<https://www.P65Warnings.ca.gov/>

Free from Conflict Minerals

This product does not contain any substances designated as "conflict minerals" such as tantalum, tin, gold or tungsten from the Democratic Republic of Congo or adjacent countries.