

Ball Casters · screwable, plain bearing

22752.0561



Product Description

For positioning and aligning of workpieces.
Because of the slide bearing, the ball can roll permanently, and the surface of the workpiece is protected.
At temperatures > 20°C, the carrying figure decreases linearly. (Example: at 90°C the load bearing capacity is max. 60%)

Material

Bearing
• plastic

Ball
• Stainless steel, hardened

Screw
• Stainless steel 1.4305

More information

Notes

Special types on request.

Drawing

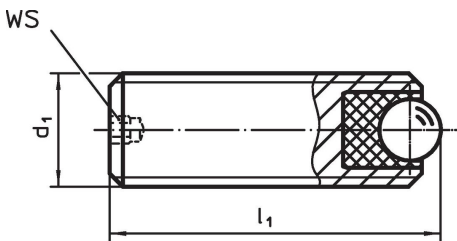

Order information

Dimensions			WS	Static carrying figure C ₀	Tightening torque max.	Temperature		Weight	Art. No.
d ₁	l ₁	Ball diameter				min.	max.		
[mm]			[mm]	[N]	[Nm]	[°C]		[g]	
Stainless steel									
M6	8	2.5	1.5	172	0.11	-50	90	1	22752.0561

Application example

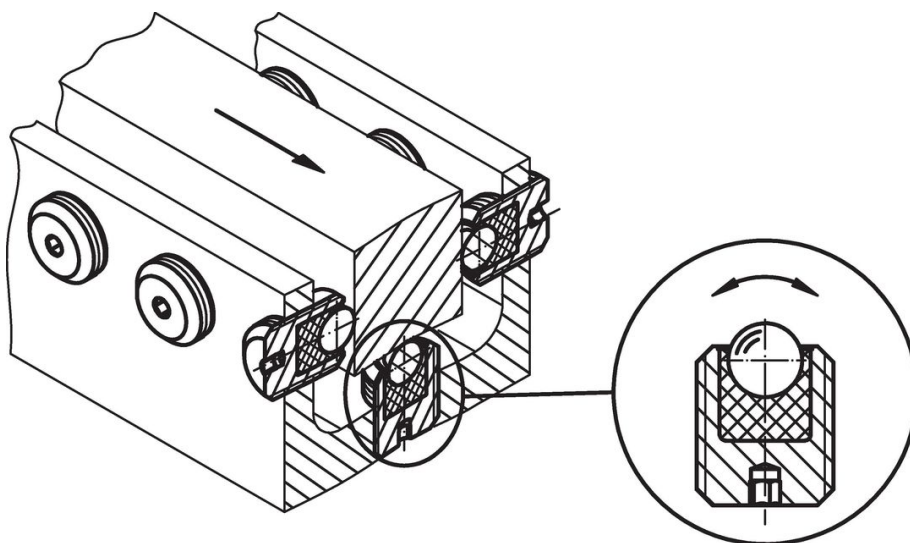

Compliance

RoHS compliant

Compliant according to Directive 2011/65/EU and Directive 2015/863.

Does not contain SVHC substances

No SVHC substances with more than 0.1% w/w contained - SVHC list [REACH] as of 23.01.2024.

Does not contain Proposition 65 substances

No Proposition 65 substances included.

<https://www.P65Warnings.ca.gov/>

Free from Conflict Minerals

This product does not contain any substances designated as "conflict minerals" such as tantalum, tin, gold or tungsten from the Democratic Republic of Congo or adjacent countries.