

Ball Casters • with sheet steel housing

22750.0012



Product Description

Ball casters are module for transport systems, conveyances, to working and packing facilities. For example, parts can be easily moved, turned and controlled. As from $d_1 = 36$ fitted with an oil drenched felt seal to protect against dirt.

Material

Cap

- Steel, zinc-plated by galvanization

Housing

- Steel, zinc-plated by galvanization

Ball

- Ball-bearing steel

More information

Further products

- Tolerance Rings

Drawing

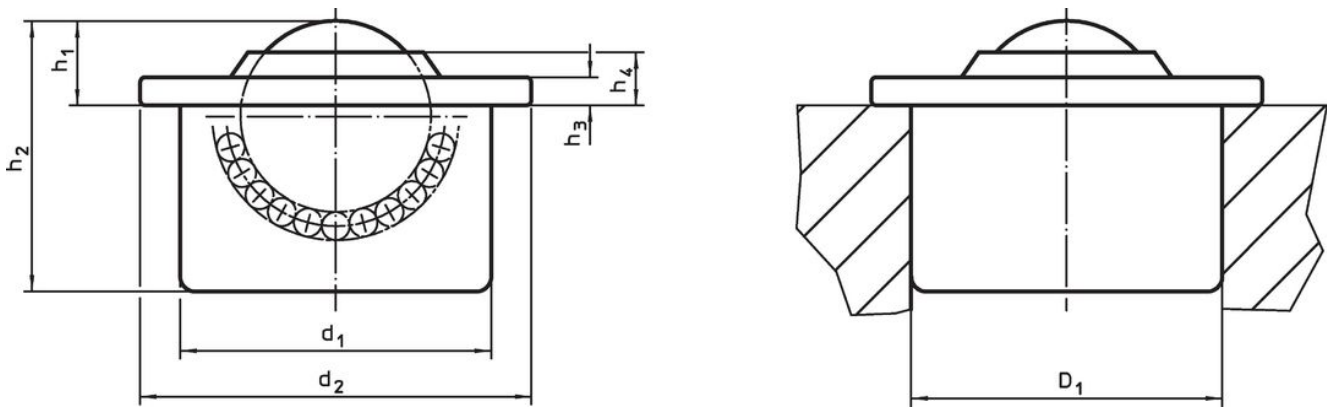

Order information

d_1 ± 0.08	Ball diameter	d_2	Dimensions				Location hole $D_1^{1)}$ $+0.05$ [mm]	Dynamic carrying figure C [N]	 [g]	Art. No.
			h_1 ± 0.3 [mm]	h_2	h_3	h_4				
cap and housing zinc-plated										
45	30	55	13.8	37.5	3.7	7.9	44.85	2500	277	22750.0012

¹⁾ Reference value for 2 mm sheet steel/ 5 mm aluminium (force fit)

Application example

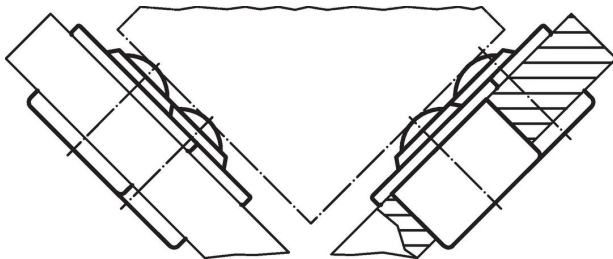



Compliance

RoHS compliant

Compliant according to Directive 2011/65/EU and Directive 2015/863.

Does not contain SVHC substances

No SVHC substances with more than 0.1% w/w contained - SVHC list [REACH] as of 23.01.2024.

Does not contain Proposition 65 substances

No Proposition 65 substances included.

<https://www.P65Warnings.ca.gov/>

Free from Conflict Minerals

This product does not contain any substances designated as "conflict minerals" such as tantalum, tin, gold or tungsten from the Democratic Republic of Congo or adjacent countries.