

Ball-Ended Thrust Screws • headless, short

22720.0730



Product Description

Ball-ended thrust screws, short execution, are particularly suitable for parallel shanks DIN 1835 E in combination, for instance, with Whistle Notch and Weldon Tool Holding Fixtures. Ball-ended thrust screws can also be used for clamping, tightening or supporting of non-parallel surfaces. The flat-faced, movable ball enables a flat load transmission.

Material

Ball

- Ball-bearing steel, hardened

Screw

- Heat-treated steel, 1200 ±100 N/mm²

More information

Notes

Ball not secured against rotating. Special types on request.

References

Thread lock on request, please refer to appendix - Technical Data -

Further products

- Ball-Ended Thrust Screws, headless, flat-faced ball

Drawing

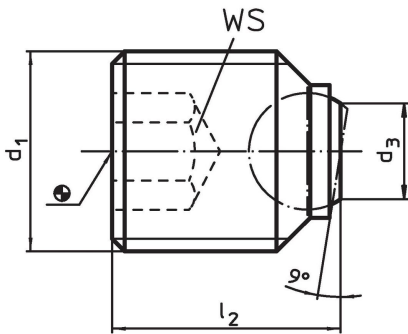

Order information

d ₁	Dimensions			Ball diameter	WS	Load capacity for static load max.	Art. No.
	l ₂	[mm]					
flat-faced ball, bearing surface plain, for straight shanks DIN 1835 E							
M24 x 2	25	13.5	15	12	90	59	22720.0730

Application example

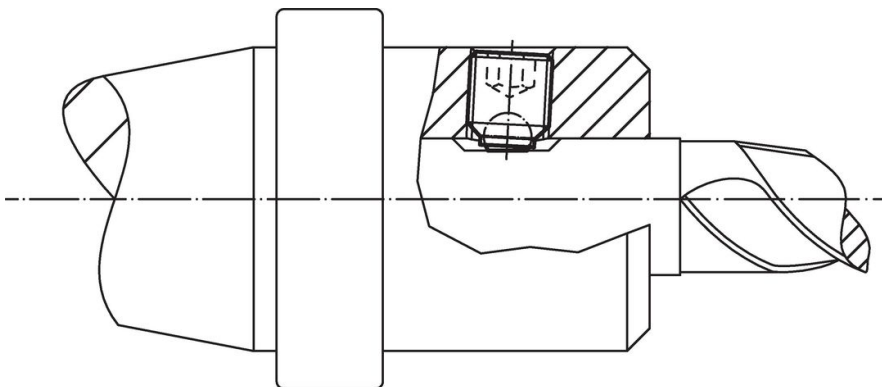

Compliance

RoHS compliant

Contains lead - compliant according to exceptions 6a / 6b / 6c.

Contains SVHC substances >0,1% w/w

Contains lead - SVHC list [REACH] as of 27.06.2024.

Contains Proposition 65 substances



Lead can cause cancer and reproductive harm from exposure
<https://www.P65Warnings.ca.gov/>

Free from Conflict Minerals

This product does not contain any substances designated as "conflict minerals" such as tantalum, tin, gold or tungsten from the Democratic Republic of Congo or adjacent countries.