

## Ball-Ended Thrust Screws • headed, ball protected against rotating

22700.0166



### Product Description

Ball-ended thrust screws can also be used for clamping, tightening or supporting of non-parallel surfaces.  
The flat-faced, movable ball enables a flat load transmission.

### Material

#### Ball

- Ball-bearing steel, hardened

#### Screw

- Heat-treated steel,  $1200 \pm 100 \text{ N/mm}^2$

### More information

#### Notes

Note: Thread runout  $l_4$  !  
Ball protected against rotating.  
Special types on request.

#### References

Thread lock on request, please refer to appendix - Technical Data -

#### Further products

- Ball-Ended Thrust Screws, headed, flat-faced ball

### Drawing



### Order information

Dimensions							WS	Load capacity for static load <sup>1)</sup> max.	g	Art. No.
$d_1$	$l_2$	$d_2$	$d_3$	$l_3$	$l_4$	Ball diameter				
[mm]							[mm]	[kN]	[g]	
flat-faced ball, bearing surface plain, Heat-treated steel										
M16	80	24	10.7	16	36	12	14	36	153	22700.0166

<sup>1)</sup> Statements on load capacity are not valid for the stainless steel type.

### Application example

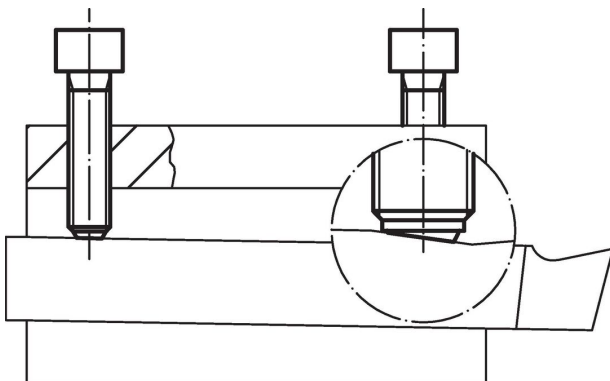



## Compliance

### RoHS compliant

Compliant according to Directive 2011/65/EU and Directive 2015/863.

### Does not contain SVHC substances

No SVHC substances with more than 0.1% w/w contained - SVHC list [REACH] as of 23.01.2024.

### Does not contain Proposition 65 substances

No Proposition 65 substances included.

<https://www.P65Warnings.ca.gov/>

### Free from Conflict Minerals

This product does not contain any substances designated as "conflict minerals" such as tantalum, tin, gold or tungsten from the Democratic Republic of Congo or adjacent countries.