

Hard Metal Inserts • for locating hole

22620.0208



Product Description

Basic element to be mounted into clamping devices, clamping jaws, clamping arms, claw feed systems and so forth.
Zero play transmission of high holding forces, e.g. on cast or forged pieces.

Material

Insert
• Hard metal, ribbed

Body

• Heat-treated steel, tempered, phosphated

Assembly

Assembly via a locating hole, the insert can be fastened by means of a screw.

Drawing

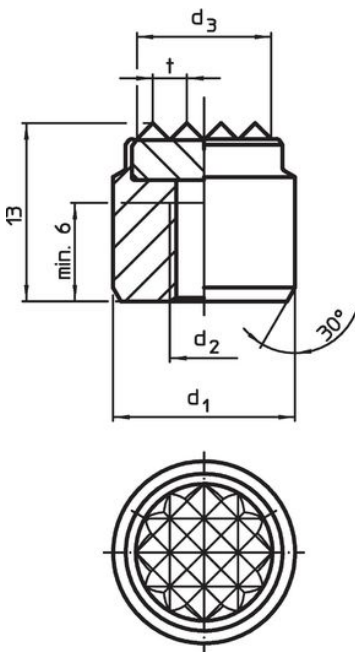

picture 1

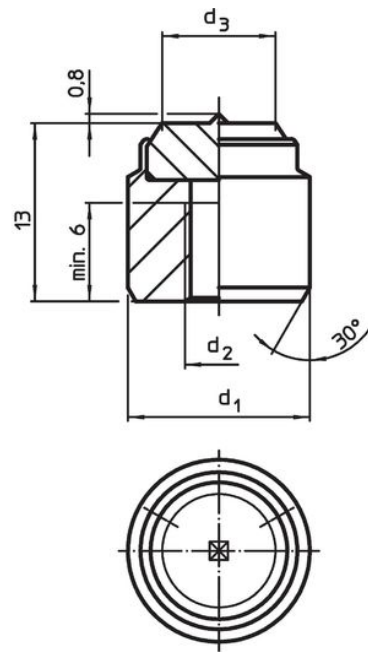

picture 2

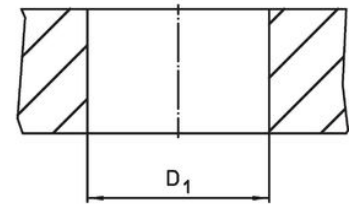

Order information

d ₁ n6	Dimensions			t	Location hole D ₁ H7 [mm]	[g]	Art. No.
	d ₂	d ₃	[mm]				
ribbed – picture 1							
10	M5	7.7		2	10	7.2	22620.0208

Application example



Compliance

RoHS compliant

Contains lead - compliant according to exceptions 6a / 6b / 6c.

Contains SVHC substances >0,1% w/w

Contains lead - SVHC list [REACH] as of 23.01.2024.

Contains Proposition 65 substances



Lead can cause cancer and reproductive harm from exposure
<https://www.P65Warnings.ca.gov/>

Free from Conflict Minerals

This product does not contain any substances designated as "conflict minerals" such as tantalum, tin, gold or tungsten from the Democratic Republic of Congo or adjacent countries.