

Grippers Round/Square • with hard metal insert, ribbed
22620.0152



Product Description

Basic element to be mounted into clamping devices, clamping jaws, clamping arms, claw feed systems and so forth.
For transmission of high turning moments and holding forces, e.g. on cast and forged pieces.

Material

Body
• Tool steel, blackened

Ribbing

• Hard metal plate, brazed-in

Assembly

Square type suitable for alignments, thus providing a bearing surface for high holding forces.

Drawing

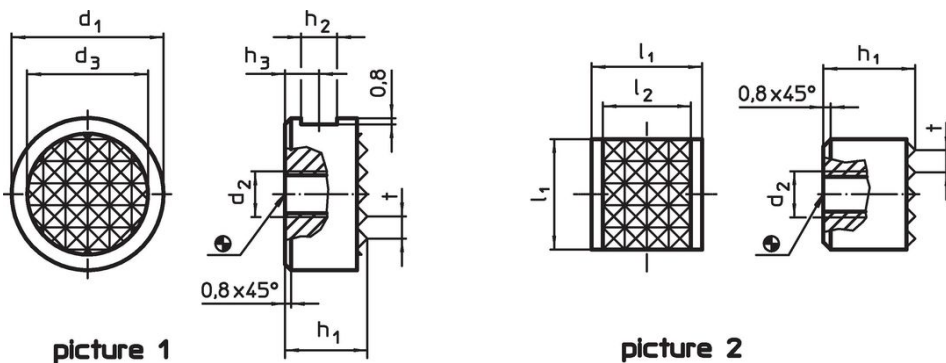

Order information

Dimensions					Art. No.
h_1 -0.13	l_1 -0.13	d_2 [mm]	l_2	t	
square – picture 2					
10	12	M5	10.3	3	11
					22620.0152

Application example

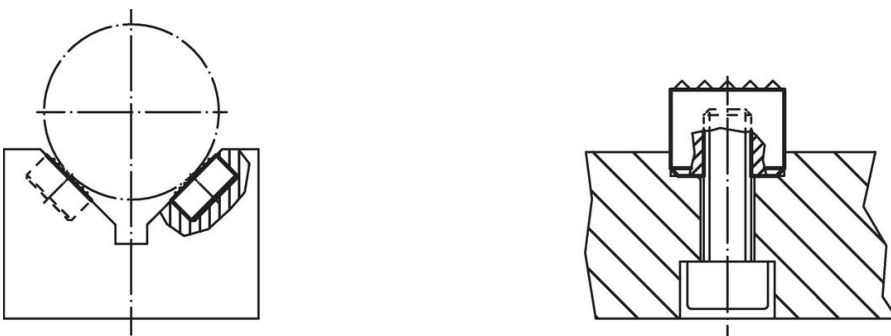

Compliance

RoHS compliant

Compliant according to Directive 2011/65/EU and Directive 2015/863.

Does not contain SVHC substances

No SVHC substances with more than 0.1% w/w contained - SVHC list [REACH] as of 23.01.2024.

Does not contain Proposition 65 substances

No Proposition 65 substances included.

<https://www.P65Warnings.ca.gov/>

Free from Conflict Minerals

This product does not contain any substances designated as "conflict minerals" such as tantalum, tin, gold or tungsten from the Democratic Republic of Congo or adjacent countries.