

Support Legs · impact cushioning

22594.0055



Product Description

The support legs are universally usable as adjustable legs. These support legs with a rubber foot have a damping, noise-reducing effect, and prevent damage to the support surface.

Material

Body

- NBR

Screw

- Steel, zinc-plated by galvanization

Disc

- Steel, zinc-plated by galvanization

More information

Further products

- Rubber Endstop Buffers, cylindrical
- Rubber Endstop Buffers, parabolic
- Rubber Endstop Buffers, truncated cone form

Drawing

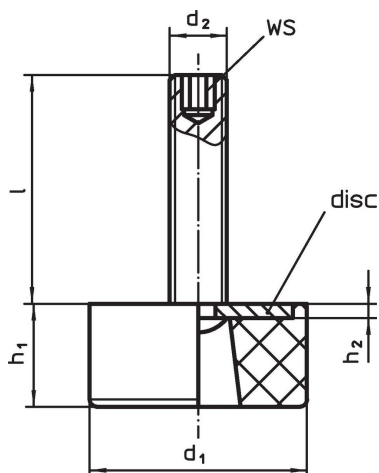

Order information

Dimensions						Load capacity for static load max. [N]	min. max. [°C]		[g]	Art. No.
d ₁	l	d ₂	h ₁	h ₂	WS					
64	45	M10	26	2.5	5	3700	-30	120	165	22594.0055

Compliance

RoHS compliant

Contains lead - compliant according to exceptions 6a / 6b / 6c.

Contains SVHC substances >0,1% w/w

Contains lead - SVHC list [REACH] as of 23.01.2024.

Contains Proposition 65 substances



Lead can cause cancer and reproductive harm from exposure

<https://www.P65Warnings.ca.gov/>

Free from Conflict Minerals

This product does not contain any substances designated as "conflict minerals" such as tantalum, tin, gold or tungsten from the Democratic Republic of Congo or adjacent countries.