

Fulcrum Screws

22591.0210



Product Description

Can be used as screw-in foot or thrust pad.
Compact design for simple levelling by means of the spanner flat at the bushing or preferably by means of an internal hexagon.

Material

Body

- Stainless steel 1.4305

Ball element

- Stainless steel 1.4305

More information

Notes

The fulcrum screws may exclusively be exposed to static loading.

Drawing

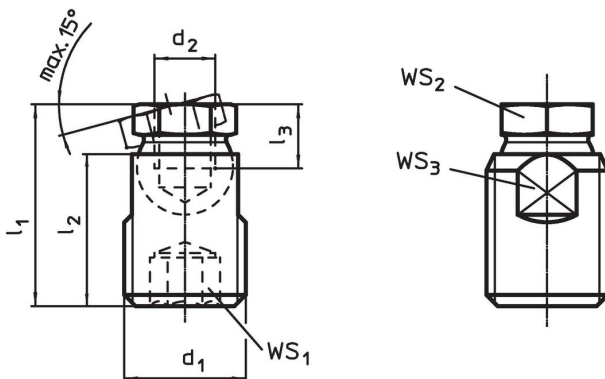

Order information

d ₁	d ₂	Dimensions			WS ₁ [mm]	WS ₂ [mm]	WS ₃ [mm]	Load capacity for static load max. [kN]	[g]	Art. No.
		l ₁ ±0.5 [mm]	l ₂	l ₃ min.						
Stainless steel										
M24	M10	39.9	30	9	12	19	20	28	87	22591.0210

Application example



Compliance

RoHS compliant

Compliant according to Directive 2011/65/EU and Directive 2015/863.

Does not contain SVHC substances

No SVHC substances with more than 0.1% w/w contained - SVHC list [REACH] as of 23.01.2024.

Does not contain Proposition 65 substances

No Proposition 65 substances included.

<https://www.P65Warnings.ca.gov/>

Free from Conflict Minerals

This product does not contain any substances designated as "conflict minerals" such as tantalum, tin, gold or tungsten from the Democratic Republic of Congo or adjacent countries.