

## Mounting Pads

22590.0672



### Product Description

Mounting pads can be used as foot or thrust pad. Not parallel bearing surfaces up to 15° degrees can be compensated.

### Material

#### Ball element with bolt

- Stainless steel 1.4305

#### Lock nut

- Stainless Steel A2, ISO 4032

#### Pad

- Stainless steel 1.4305

### More information

#### Notes

For the versions  $d_1 = M10$  and  $M12$  the lock nut conforms to DIN 934.

Drawing

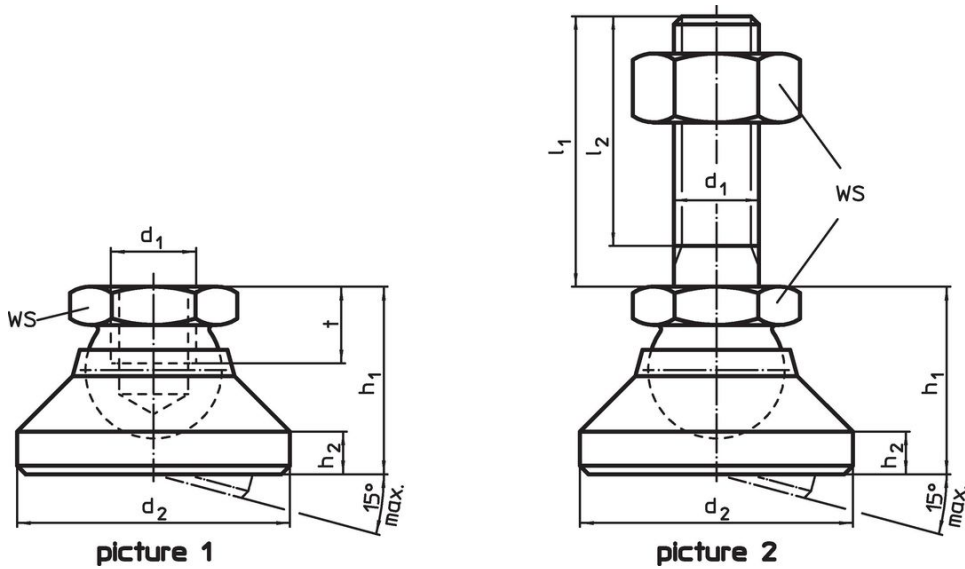

Order information

Dimensions						WS	Load capacity for static load max.	max.		Art. No.
$d_1$	$l_1$	$d_2$	$l_2$	$h_1$	$h_2$					
[mm]						[mm]	[kN]	[°C]	[g]	
pad and ball element with bolt from steel – picture 2, Stainless steel										
M16	200	50	194	32	7	24	36	250	624	22590.0672

Application example

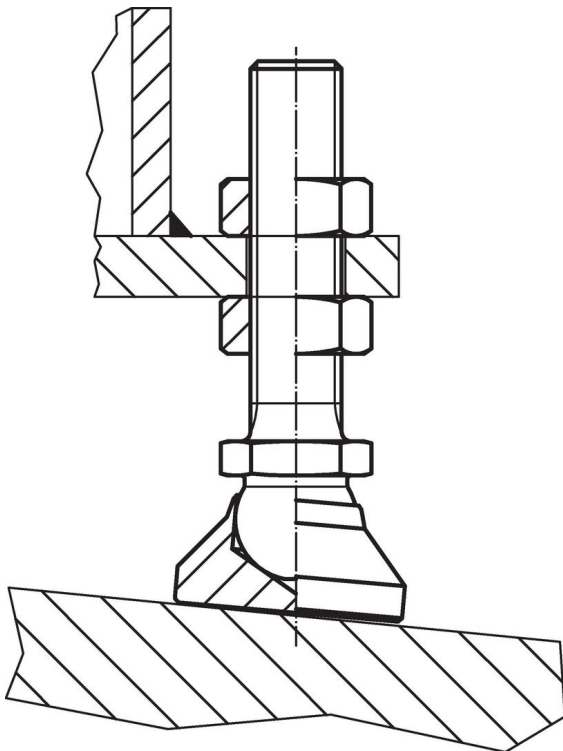

## Compliance

### RoHS compliant

Compliant according to Directive 2011/65/EU and Directive 2015/863.

### Does not contain SVHC substances

No SVHC substances with more than 0.1% w/w contained - SVHC list [REACH] as of 27.06.2024.

### Does not contain Proposition 65 substances

No Proposition 65 substances included.

<https://www.P65Warnings.ca.gov/>

### Free from Conflict Minerals

This product does not contain any substances designated as "conflict minerals" such as tantalum, tin, gold or tungsten from the Democratic Republic of Congo or adjacent countries.