

Grub Screws • ball-headed
22570.0228



Product Description

The ball-headed grub screws (EH 22570.) can be combined with plastic thrust pads (EH 22570.).

Material

- Free cutting steel, quality 5.8, blackened

More information

Further products

- Thrust Pads, plastic

Drawing

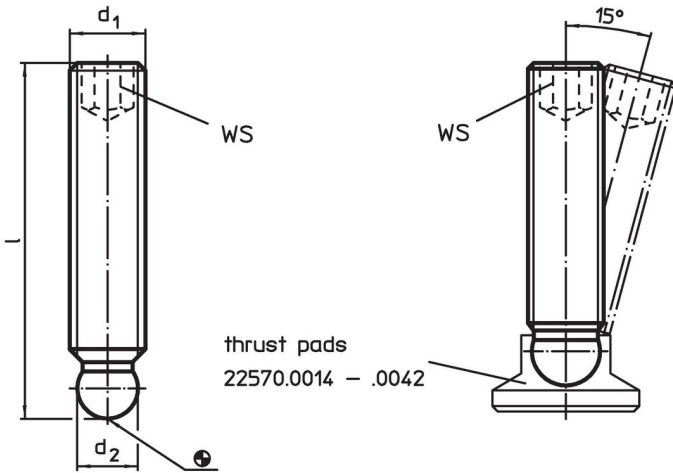

Order information

d ₁	Dimensions l [mm]	d ₂ +0.05	WS [mm]	 [g]	Art. No.
Free cutting steel					
M8	63	6.1	4	18	22570.0228

Application example



Compliance

RoHS compliant

Contains lead - compliant according to exceptions 6a / 6b / 6c.

Contains SVHC substances >0,1% w/w

Contains lead - SVHC list [REACH] as of 23.01.2024.

Contains Proposition 65 substances



Lead can cause cancer and reproductive harm from exposure
<https://www.P65Warnings.ca.gov/>

Free from Conflict Minerals

This product does not contain any substances designated as "conflict minerals" such as tantalum, tin, gold or tungsten from the Democratic Republic of Congo or adjacent countries.