

Thrust Pads · plastic

22570.0024



Product Description

The plastic thrust pads (EH 22570.) can be combined with ball-headed grub screws (EH 22570.).

Material

- Thermoplastic POM, black, dull

More information

Further products

- Grub Screws, ball-headed
- Seating Elements, with plastic bearing surface, orienting

Drawing

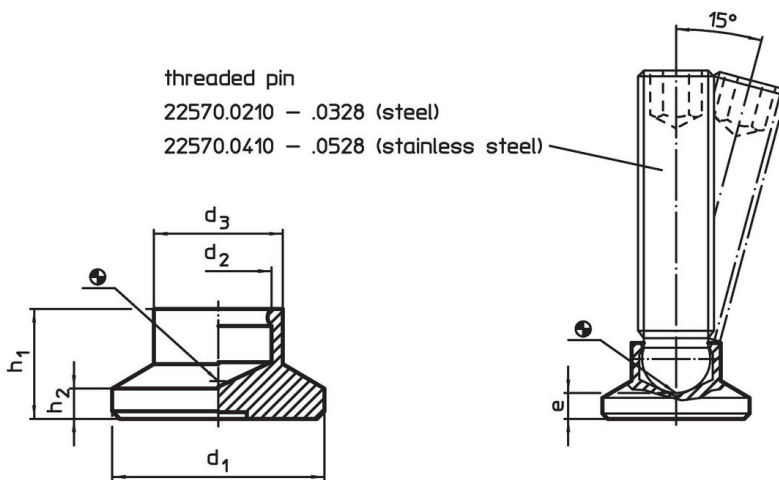

Order information

Dimensions						Load capacity for static load max.	For grub screws EH 22570.	Temperature		Weight	Art. No.
d ₁	d ₂	d ₃	e	h ₁	h ₂			min.	max.		
[mm]						[kN]	[mm]	[°C]		[g]	
25	7.8	13	4.6	10.5	3	3.5	M10	-30	80	3.6	22570.0024

Application example

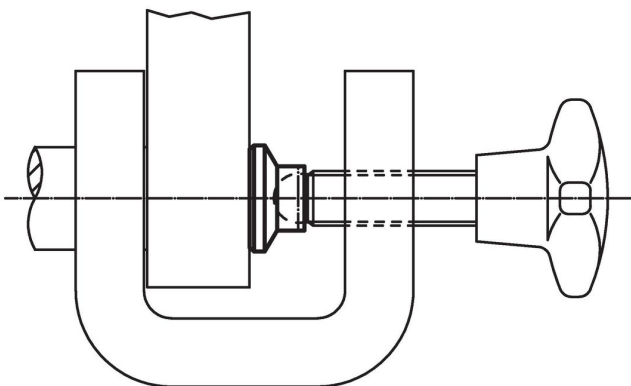

Compliance

RoHS compliant

Compliant according to Directive 2011/65/EU and Directive 2015/863.

Does not contain SVHC substances

No SVHC substances with more than 0.1% w/w contained - SVHC list [REACH] as of 23.01.2024.

Does not contain Proposition 65 substances

No Proposition 65 substances included.

<https://www.P65Warnings.ca.gov/>

Free from Conflict Minerals

This product does not contain any substances designated as "conflict minerals" such as tantalum, tin, gold or tungsten from the Democratic Republic of Congo or adjacent countries.