

Grub Screws • DIN 6332 with thrust point

22540.1503



Product Description

Grub screws are clamping screws that can directly transmit forces via the thrust point. The pressure surface of the thrust point of the steel version is hardened.

For clamping sensitive surfaces, thrust pads EH 22560. (DIN 6311 and low version) can be attached on the thrust point. The snap ring of the thrust pad achieves a connection between the grub screw and the thrust pad that can be released by hand.

These grub screws with thrust points are particularly characterised by the additional radius "r" on the thrust point (optimisation compared to DIN 6332), which makes assembly in the thrust pad much easier.

The thrust point diameter of the grub screws is smaller than the core diameter of the thread, so that they can also be screwed in on the pin side.

Material

- Stainless steel

More information

Further products

- Thrust Pads, DIN 6311 and low model

Drawing

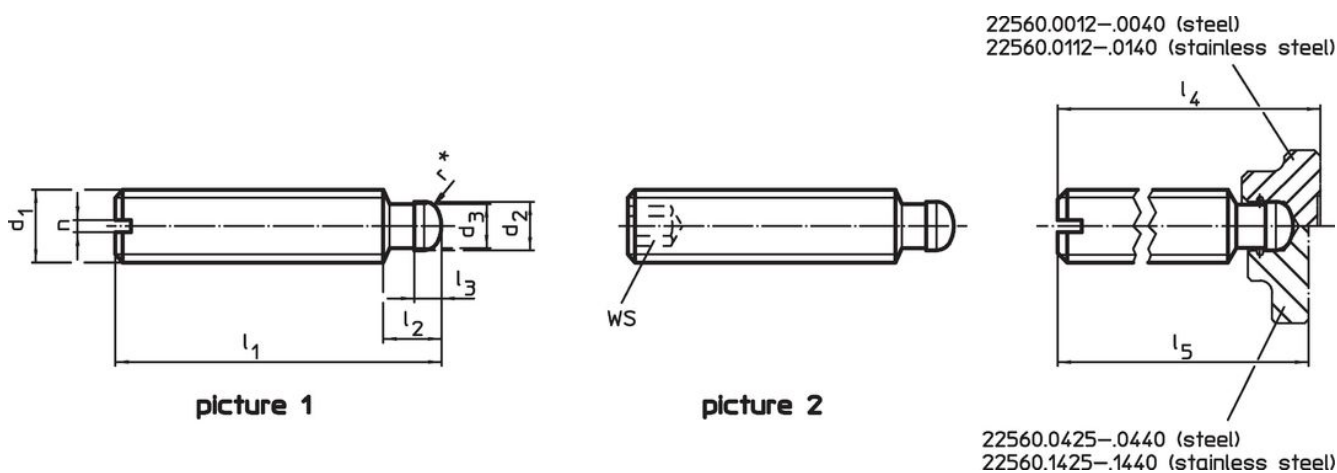

* to ease assembly the DIN 6332 specification has been completed by r

Order information

d ₁	l ₁	d ₂ h11	Dimensions				l ₄ ~	WS [mm]	[g]	Art. No.
			d ₃ [mm]	l ₂	l ₃					
with internal hexagon (IS) – picture 2, Stainless steel										
M20	150	15.5	14.4	14	5.5	155.5	10	284	22540.1503	

Application example



Compliance

RoHS compliant

Compliant according to Directive 2011/65/EU and Directive 2015/863.

Does not contain SVHC substances

No SVHC substances with more than 0.1% w/w contained - SVHC list [REACH] as of 27.06.2024.

Does not contain Proposition 65 substances

No Proposition 65 substances included.

<https://www.P65Warnings.ca.gov/>

Free from Conflict Minerals

This product does not contain any substances designated as "conflict minerals" such as tantalum, tin, gold or tungsten from the Democratic Republic of Congo or adjacent countries.