

Locating Bushings, plain • for lifting pins

22350.1924



Product Description

Locating bushings are used for quick and safe locating of lifting pins EH 22350 / EH 22351. This design is suitable for applications which require installation flush to the surface. A face wrench is required for installation. As an accessory, we offer a standard adjustable face wrench, offset, and a face and socket wrench. In combination with a socket-wrench/screwdriver, the face and socket wrench is especially suitable for use if space is restricted. Corrosion and abrasion resistant.

Material

- Stainless steel 1.4542, precipitation-hardened

Assembly

Safe tolerances and consistent function. Easily incorporated into different materials. Bush can be easily installed via optional assembly tool. Can be mounted in blind holes. For thin-walled parts, lock nuts are used for assembly.

Drawing

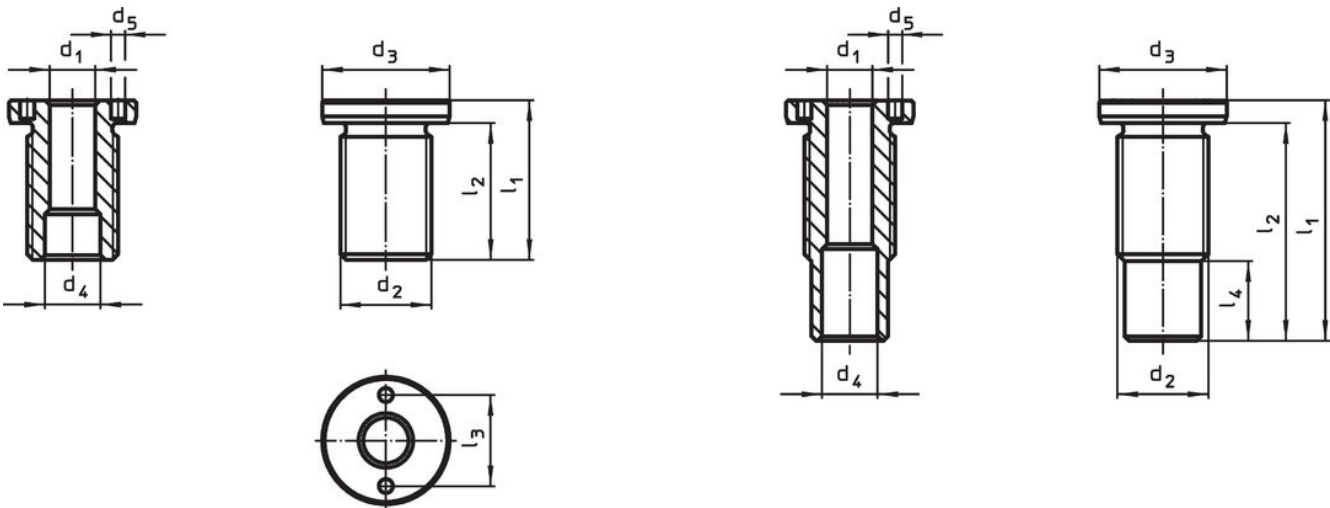



size M16/M16x1,5/M20
M20x1,5/M24x1,5/M30x2

size M24/M30/M36x2

Order information

Dimensions		For nominal length	Dimensions							Tightening torque max.	x	Load capacity			For lifting pin	Art. No.	
d ₁	d ₂		d ₃	d ₄	d ₅	l ₁	l ₂	l ₃	l ₄			F ₁	F ₂	F ₃			
H11	[mm]	[mm]	-0.2	+0.3	+0.1	[mm]				[Nm]	[mm]	[kN]		[g]			
12	M24	35	32	14.7	5.1	50	44	22	3.8	150	1.5	3.5	3.2	2.8	22350.0635 / .0735	116	22350.1924

Accessories

	Suitable for size d_1 [mm]	Pin spacing ± 0.1 [mm]	Pin diameter -0.1 [mm]	Square drive [in]	 [g]	Art. No.
adjustable face wrench, offset						
	10/12/16/20/25	-	5		309	22350.1991
face wrench (socket wrench insert)						
	12	22	5	1/2	185	22350.1997

Application example

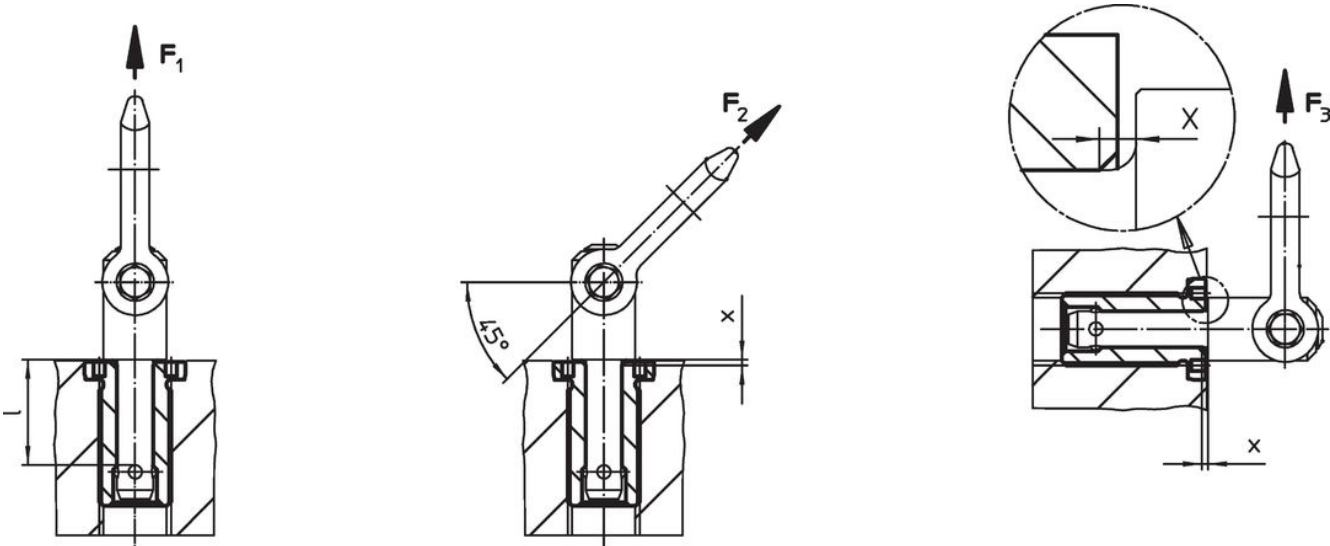

Compliance

RoHS compliant

Compliant according to Directive 2011/65/EU and Directive 2015/863.

Does not contain SVHC substances

No SVHC substances with more than 0.1% w/w contained - SVHC list [REACH] as of 23.01.2024.

Does not contain Proposition 65 substances

No Proposition 65 substances included.

<https://www.P65Warnings.ca.gov/>

Free from Conflict Minerals

This product does not contain any substances designated as "conflict minerals" such as tantalum, tin, gold or tungsten from the Democratic Republic of Congo or adjacent countries.