

## Locating Bushings, plain • for lifting pins

22350.1902



### Product Description

Locating bushings are used for quick and safe locating of lifting pins EH 22350 / EH 22351. This design is suitable for applications which require installation flush to the surface. A face wrench is required for installation. As an accessory, we offer a standard adjustable face wrench, offset, and a face and socket wrench. In combination with a socket-wrench/screwdriver, the face and socket wrench is especially suitable for use if space is restricted. Corrosion and abrasion resistant.

### Material

- Stainless steel 1.4542, precipitation-hardened

### Assembly

Safe tolerances and consistent function. Easily incorporated into different materials. Bush can be easily installed via optional assembly tool. Can be mounted in blind holes. For thin-walled parts, lock nuts are used for assembly.

### Drawing

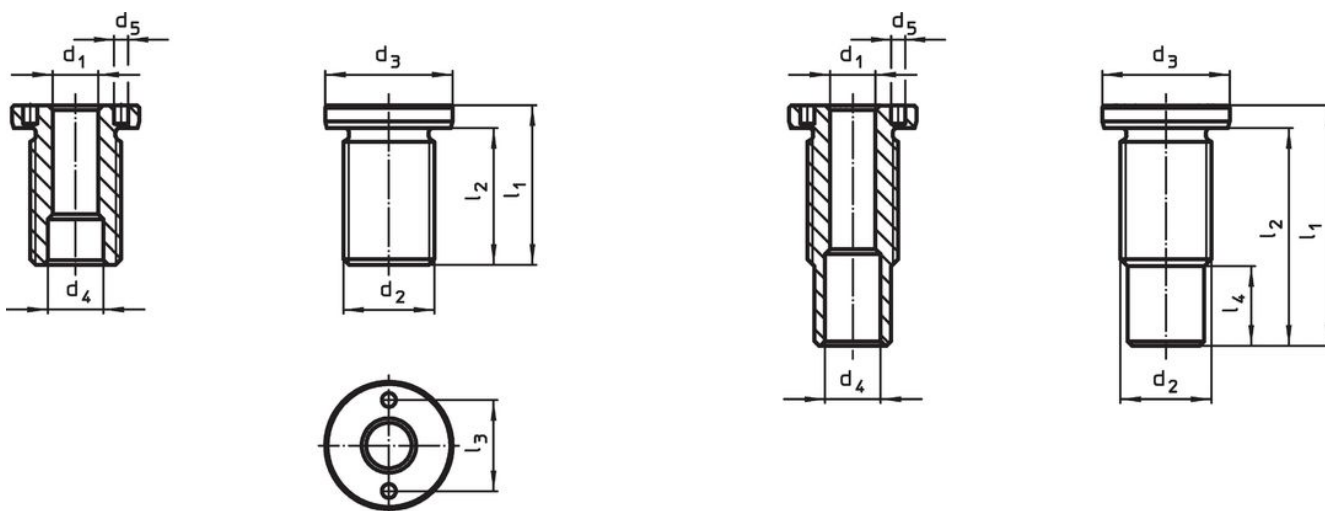



size M16/M16x1,5/M20  
M20x1,5/M24x1,5/M30x2

size M24/M30/M36x2

### Order information

Dimensions		For nominal length	Dimensions						Tightening torque max.	x	Load capacity			For lifting pin	Art. No.	
d <sub>1</sub>	d <sub>2</sub>		d <sub>3</sub>	d <sub>4</sub>	d <sub>5</sub>	l <sub>1</sub>	l <sub>2</sub>	l <sub>3</sub>			F <sub>1</sub>	F <sub>2</sub>	F <sub>3</sub>			
H11	[mm]	[mm]	-0.2	+0.3	+0.1	[mm]			[Nm]	[mm]	[kN]		[g]			
8	M16 x 1,5	15	24	9.8	3.1	25	20	16	75	1.5	1.5	1.2	0.5	22350.0602 / .0702	32	22350.1902

Accessories

	Suitable for size $d_1$ [mm]	Pin spacing $\pm 0.1$ [mm]	Pin diameter $-0.1$ [mm]	Square drive [in]	 [g]	Art. No.
<b>adjustable face wrench, offset</b>						
	8	-	3		121	22350.1990
<b>face wrench (socket wrench insert)</b>						
	8	16	3	1/2	116	22350.1995

Application example

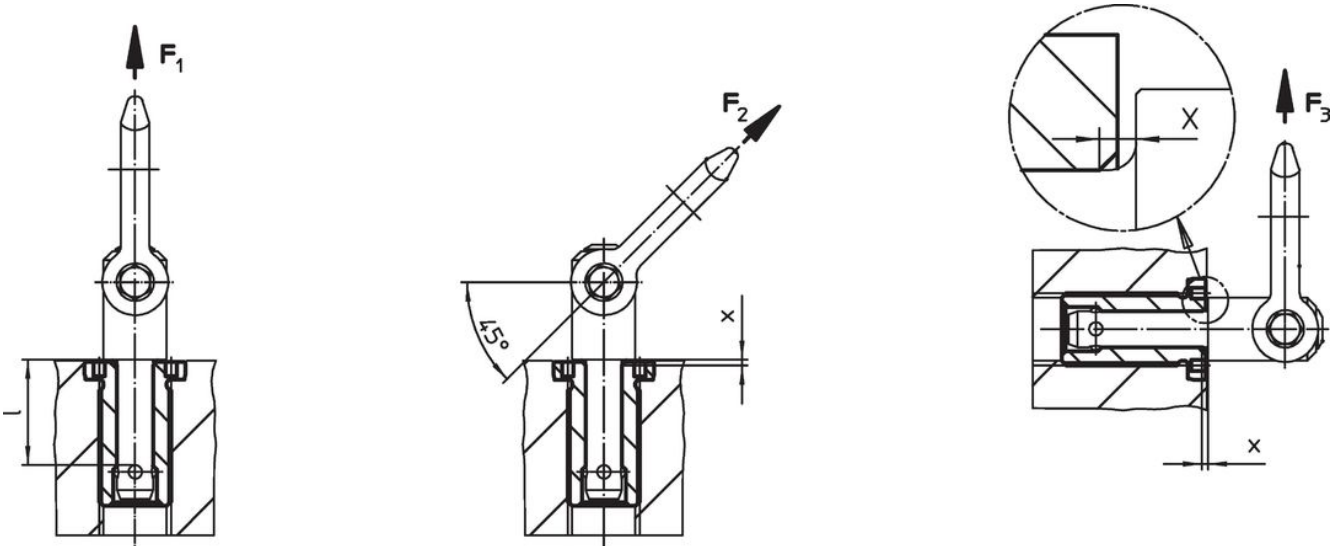

Compliance

**RoHS compliant**

Compliant according to Directive 2011/65/EU and Directive 2015/863.

**Does not contain SVHC substances**

No SVHC substances with more than 0.1% w/w contained - SVHC list [REACH] as of 23.01.2024.

**Does not contain Proposition 65 substances**

No Proposition 65 substances included.

<https://www.P65Warnings.ca.gov/>

**Free from Conflict Minerals**

This product does not contain any substances designated as "conflict minerals" such as tantalum, tin, gold or tungsten from the Democratic Republic of Congo or adjacent countries.