

Ball Lock Pins • self-locking, with L-handle

22350.0128



Product Description

For quick fastening, locking, adjusting, changing and securing. Quickly and easily unlockable for frequently repeated connections.

All versions are corrosion resistant. When using stainless steel 1.4542: high-strength, hardened, abrasion resistant pin with high load capacity.

Version with ergonomic grip.

Material

Pin part

- Stainless steel 1.4542, precipitation-hardened

Handle

- Aluminium, black similar to RAL 9005

Press button

- Stainless steel, black

Spring

- Stainless steel

Operation

The balls are unlocked by pressing the button.

Characteristic

Types from stainless steel 1.4542 with marking below the balls.

More information

Notes

Special types on request.

- This product is also available in INCH dimensions.

Accessories

Can easily be fitted with retaining cable EH 22400.

Further products

- Locating Bushings, for ball lock pins and socket pins
- Locating Bushings, with flange, for ball lock pins and socket pins
- Retaining Cables
- Positioning Bushings, with collar, DIN 172 A
- Positioning Bushings, without collar, DIN 179 A
- Ball Lock Pins with L-handle, single acting - comply with NAS / MS17986

Drawing



** Types from stainless steel 1.4542 with marking.

Order information

Dimensions											Location hole	Temperature		Weight	Shearing resistance, two-shear ¹⁾ min.	Art. No.
d ₁	l ₁	d ₂	d ₃	l ₂	l ₃	l ₄	l ₅	l ₆	l ₇	H11	min.	max.	[g]			
[mm]											[mm]	[°C]				
Stainless steel																
6	40	7	11.8	7	31.6	21.9	43.8	12.6	8.5	6	-30	150	27	35	22350.0128	

¹⁾ Shearing resistance similar to DIN 50141

Application example

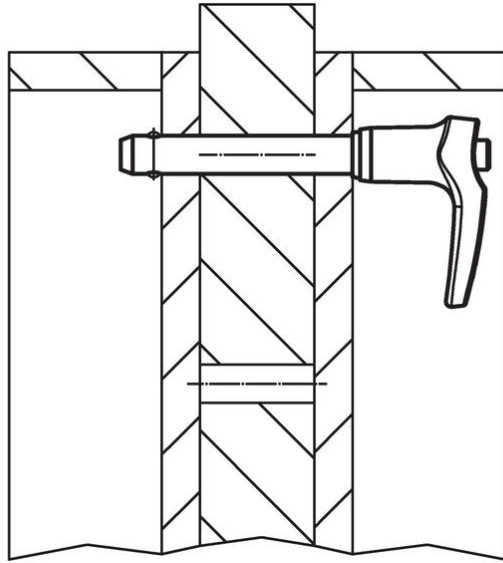

Compliance

RoHS compliant

Compliant according to Directive 2011/65/EU and Directive 2015/863.

Does not contain SVHC substances

No SVHC substances with more than 0.1% w/w contained - SVHC list [REACH] as of 23.01.2024.

Does not contain Proposition 65 substances

No Proposition 65 substances included.

<https://www.P65Warnings.ca.gov/>

Free from Conflict Minerals

This product does not contain any substances designated as "conflict minerals" such as tantalum, tin, gold or tungsten from the Democratic Republic of Congo or adjacent countries.