

Ball Lock Connectors • self-locking, with holder

22330.0121



Product Description

Parts can be connected fast and easily with the ball lock connector in combination with the locating bushings.

The locating bushings are made from stainless steel. There are three versions available - mounting in wood (picture 2 and picture 4), one version that can be mounted in plastic (picture 3) and with holding (picture 5 and picture 6). In the bushings (picture 2, picture 3 and picture 5) the ball lock connector is lockable (4x90°). In the bushings (picture 4 and picture 6) the ball lock connector is rotatable.

As a robust tool, the item is made from stainless steel. The ball lock connector is maintenance-free, soundless and secured against loss.

Material

Pin part

- Stainless steel 1.4305

Holder

- Stainless steel

Ball

- Stainless steel

Spring

- Stainless steel

Assembly

Mounting into wood (picture 2 and picture 4)

1. Insert location hole and pilot hole for safety bolt according to specifications
2. Optionally recommended is the use of adhesive for securing
3. Press in bushing
4. Secure bushing with a screw

Note: The bore diameter (D_2) for the pilot hole of the safety bolt depends on the screw used.

Mounting into plastic (picture 3)

1. Insert location hole according to instructions
2. Optionally recommended is the use of adhesive for securing
3. Screw in bushing

Note: The bore diameter to be chosen for the location hole depends on the hardness of the plastic.

Operation

The balls are unlocked by pressing the button.

Characteristic

Marking groove if dimension = 1,5 mm for l_1 (bushings - pictures 2, 3 and 4) or l_2 (ball lock connector - picture 1).

More information

Notes

Special types on request.

Further products

- Ball Lock Connectors, self-locking, with holding rings
- Ball Lock Connectors, self-locking, with holder, compact construction

Drawing

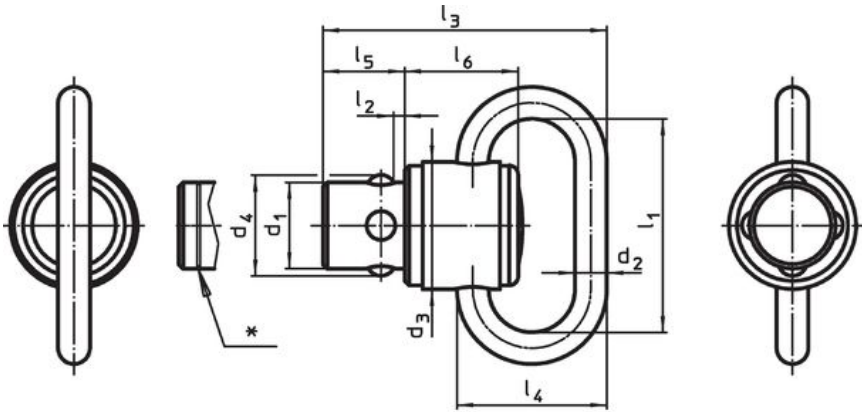

picture 1

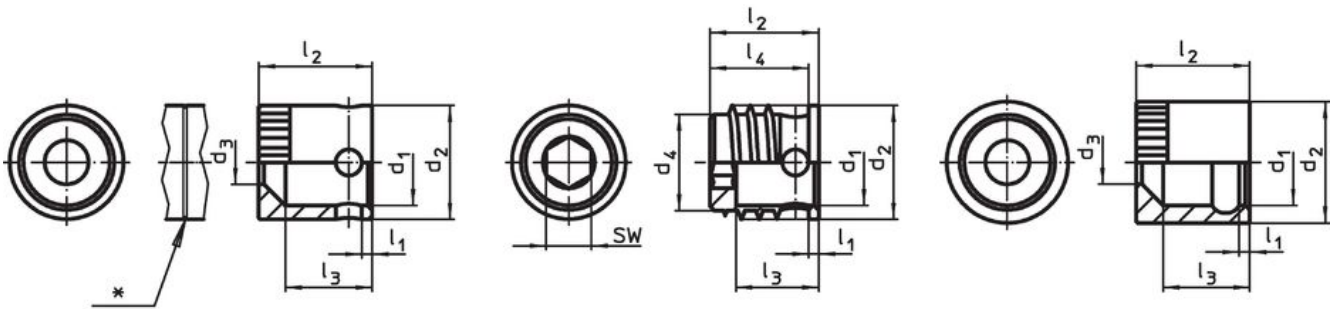

picture 2

picture 3

picture 4

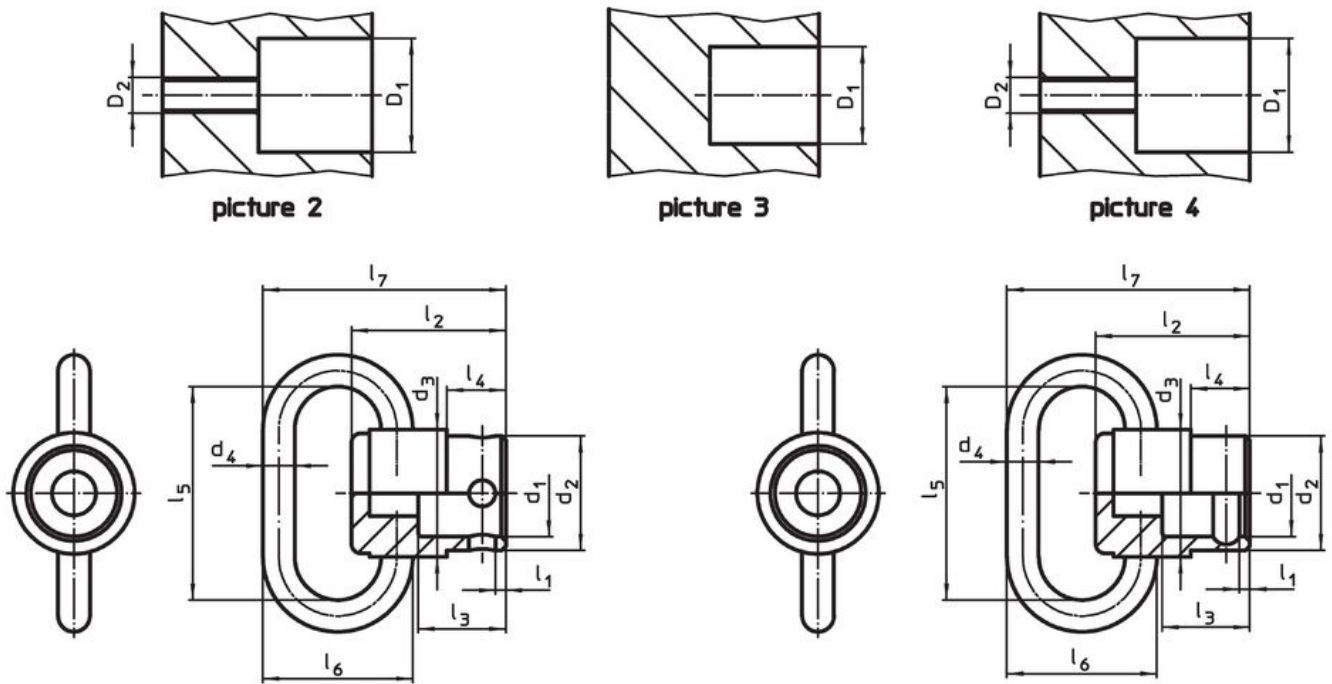

picture 5

picture 6

* Marking if dimension = 1,5 mm for l_1 (pictures 2,3 and 4) or l_2 (picture 1).

Order information

Nominal diameter d_1 [mm]	Dimensions										Load capacity max. [kN]	Temperature		Weight [g]	Art. No.
	l_1	l_2	d_2	d_3	d_4	l_3	l_4	l_5	l_6	min.		max.	[°C]		
Ball Lock Connectors – picture 1															
9.5	40	1.5	4.5	14	11.1	36.6	23	9	12.5	2	-50	150	28	22330.0121	

Application example



Compliance

RoHS compliant

Compliant according to Directive 2011/65/EU and Directive 2015/863.

Does not contain SVHC substances

No SVHC substances with more than 0.1% w/w contained - SVHC list [REACH] as of 23.01.2024.

Does not contain Proposition 65 substances

No Proposition 65 substances included.

<https://www.P65Warnings.ca.gov/>

Free from Conflict Minerals

This product does not contain any substances designated as "conflict minerals" such as tantalum, tin, gold or tungsten from the Democratic Republic of Congo or adjacent countries.