

Shaft-End Washers

22270.0045



Product Description

Material

- Free cutting steel, unhardened, blackened

Drawing

for countersunk screw
DIN EN ISO 2009
or DIN EN ISO 10642

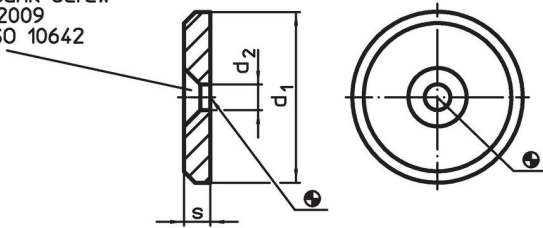

Order information

d ₁	Dimensions		s	[g]	Art. No.
	d ₂	[mm]			
45	6.6		6	66	22270.0045

Application example

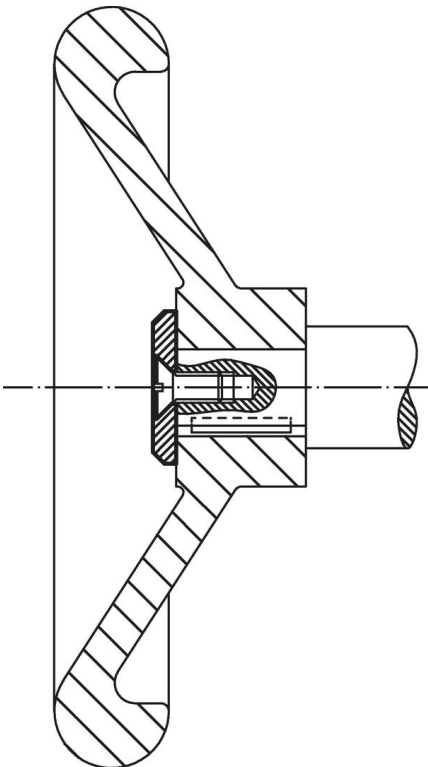

Compliance

RoHS compliant

Contains lead - compliant according to exceptions 6a / 6b / 6c.

Contains SVHC substances >0,1% w/w

Contains lead - SVHC list [REACH] as of 23.01.2024.

Contains Proposition 65 substances



Lead can cause cancer and reproductive harm from exposure
<https://www.P65Warnings.ca.gov/>

Free from Conflict Minerals

This product does not contain any substances designated as "conflict minerals" such as tantalum, tin, gold or tungsten from the Democratic Republic of Congo or adjacent countries.