

## Clamping Catches

22260.0250



### Product Description

Clamping catches have a round running taper surface and enable fast and safe clamping and releasing with a relatively large adjustment range and high tensioning force. Due to the small gradient angle of the taper surface, the clamping catch is self-locking.

### Material

#### Body

- Steel, case-hardened, blackened

#### Screw

- Steel, nitrided

#### Gear lever handle

- Steel, ground, blackened

#### Ball knob

- Thermosetting plastic PF 31, black, DIN 319

### Assembly

Fix with screw bolt M 10 (WS 6). Ensure a tightening torque of max. 40 Nm.

### Operation

The screw bolt and the washer are adjustable. Once screwed in, the clamping catch can easily be turned to the desired position. For Art. No. 22260.0250 / .0251 and 22260.0450 / .0451, the serration helps to put the tension lever to the preferred position.

### More information

### Notes

Left turn type can be supplied on request.

### Drawing

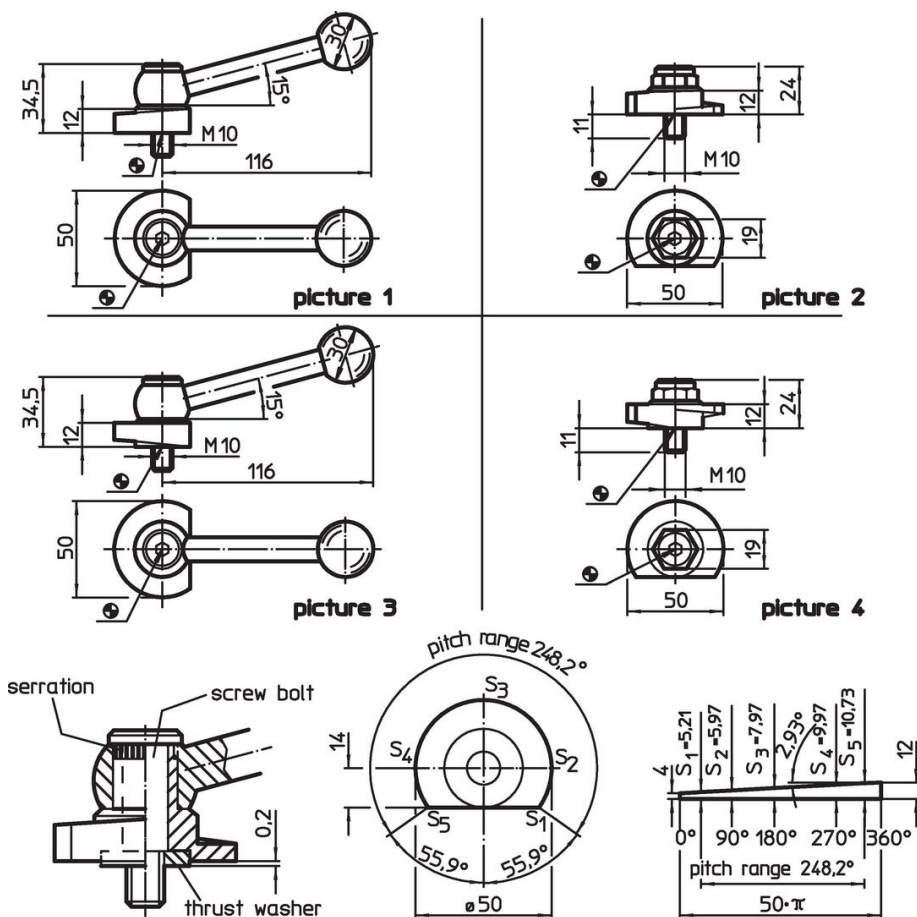

Order information

Tightening torque max. [Nm]	 [g]	Art. No.
40	304	22260.0250

Application example



## Compliance

### RoHS compliant

Contains lead - compliant according to exceptions 6a / 6b / 6c.

### Contains SVHC substances >0,1% w/w

Contains lead - SVHC list [REACH] as of 23.01.2024.

### Contains Proposition 65 substances



Lead can cause cancer and reproductive harm from exposure  
<https://www.P65Warnings.ca.gov/>

### Free from Conflict Minerals

This product does not contain any substances designated as "conflict minerals" such as tantalum, tin, gold or tungsten from the Democratic Republic of Congo or adjacent countries.