

Spring-Loaded Catches • DIN 6310 catches with spring

22200.0080



Product Description

The catches with spring, manufactured according to DIN 6310, are used as locking elements, for example.

Material

- Heat-treated steel, blackened. Hardened where shown by ___ line.

Drawing

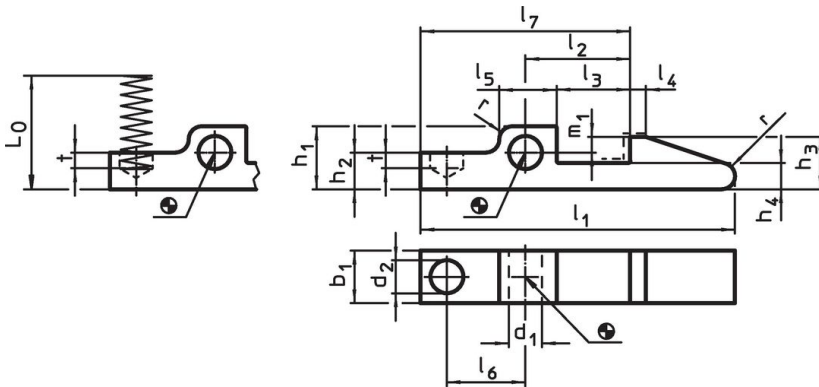

Hardened where shown by ___ line.

Order information

Dimensions																	Spring rate R ~ [N/mm]	[g]	Art. No.	
l_1	b_1 -0.2	d_1 E9	d_2	h_1	h_2	h_3	h_4	l_2 ± 0.1	l_3	l_4	l_5	l_6	l_7	m_1	t	r				L_0 ~
[mm]																				
80	14	6	8	15	9	14	7	30	22	5	14	23	60	5	5	4	25.1	4.8	80	22200.0080

Application example

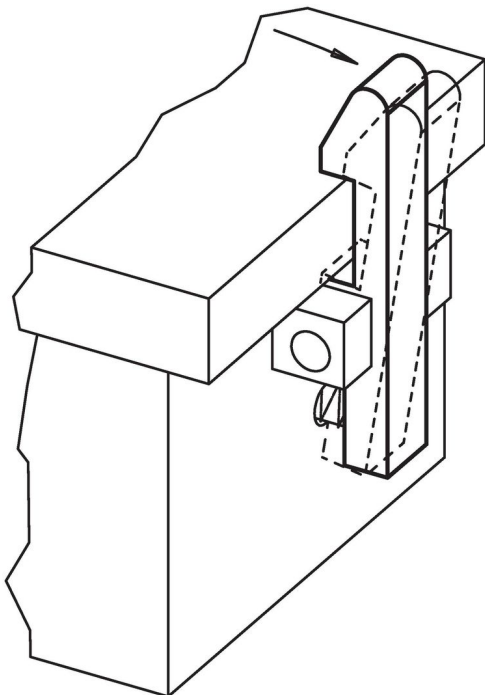

Compliance

RoHS compliant

Compliant according to Directive 2011/65/EU and Directive 2015/863.

Does not contain SVHC substances

No SVHC substances with more than 0.1% w/w contained - SVHC list [REACH] as of 23.01.2024.

Does not contain Proposition 65 substances

No Proposition 65 substances included.

<https://www.P65Warnings.ca.gov/>

Free from Conflict Minerals

This product does not contain any substances designated as "conflict minerals" such as tantalum, tin, gold or tungsten from the Democratic Republic of Congo or adjacent countries.