

Lateral Plungers · with thread, with seal, with female thread

22150.1431



Product Description

To be used for positioning and applying pressure, e.g. during painting and sandblasting. Sealed against chips and dirt.

Material

Seal

- CR

Body

- Steel, zinc-plated

Threaded washer

- Steel, blackened

Spring

- Steel, blackened

Assembly

Formula for calculating the center distance for the mounting hole:

$$l_0 = z/2 + w + x,$$

l_0 = center distance,

y = workpiece height,

w = workpiece length,

x = stroke,

z = stop diameter

Calculation dimension x for workpieces:

$$x = d_2/2 - s$$

Lateral plungers are installed by screwing in by means of a mounting tool.

Characteristic

Version standard spring load = spring from steel, blackened

More information

Notes

Individual set screws can be screwed in the plate with threaded hole.

Drawing

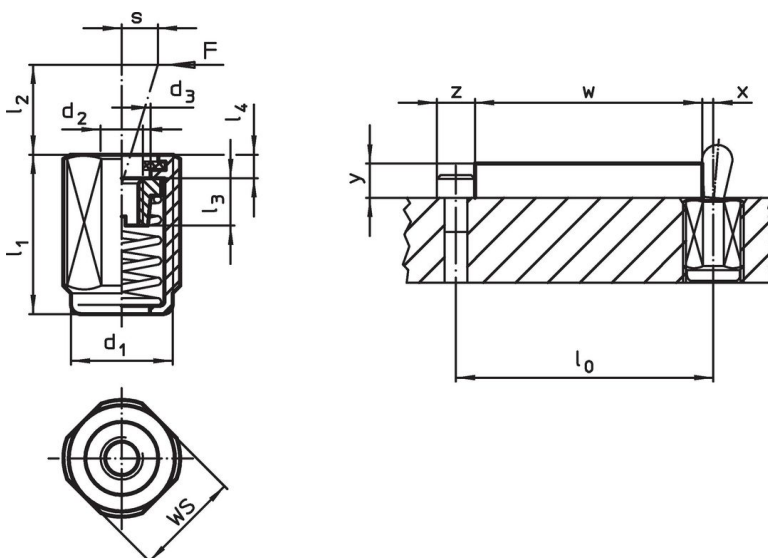

Order information

Dimensions		Spring load F max. ¹⁾ ~ [N]	Dimensions					Stroke s [mm]	WS [mm]	max. [°C]	[g]	Art. No.
d ₁ [mm]	l ₁ -2 [mm]		d ₂ [mm]	d ₃ [mm]	l ₂ [mm]	l ₃ [mm]	l ₄ [mm]					
Standard spring load												
M12	11.5	75	M4	6.1	10	4.5	2	1	10	110	3.3	22150.1431

¹⁾ statistical average value

Accessories

	Dimensions d ₁ [mm]	[g]	Art. No.
assembly tool			
	M12	76	22150.0820

Application example



Compliance

RoHS compliant

Contains lead - compliant according to exceptions 6a / 6b / 6c.

Contains SVHC substances >0,1% w/w

Contains lead - SVHC list [REACH] as of 23.01.2024.

Contains Proposition 65 substances



Lead can cause cancer and reproductive harm from exposure
<https://www.P65Warnings.ca.gov/>

Free from Conflict Minerals

This product does not contain any substances designated as "conflict minerals" such as tantalum, tin, gold or tungsten from the Democratic Republic of Congo or adjacent countries.