

Index Plungers • with sensor

22123.0104



Product Description

Index plungers are used for indexing bores. The index plunger with sensor makes it possible to monitor the indexing position of the indexing plunger. When it engages, the sensor already switches after 2/3 of the indexing distance l_2 . In addition to the electronic signal, the switching status is indicated directly on the sensor via an LED.

Material

Body

- Stainless steel 1.4305

Locking pin

- Stainless steel 1.4305, nickel-plated

Knob

- Thermoplastic PA 6, black, dull

Cable

- Thermoplastic PUR, black

Magnet

- Permanent magnet

Sensor

- Thermoplastic PA 6, black, dull

Lock nut

- Stainless steel A2 (ISO 8675)

Assembly

The enclosed separate sensor and sensor clip can be mounted with the enclosed Allen key. The derivation direction of the sensor cable can be determined individually.

1. Push the sensor into the side of the sensor clip.
2. Tighten the internal hexagon screw of the sensor with light hand force (max. 0.1 Nm).
3. Clip the sensor clip into the annular groove of the index plunger in any position.
4. By turning the sensor clip, the sensor cable's derivation direction can be adjusted.

Note:

To avoid interferences, no magnetic fields should act on the index plunger.

Operation

When using locking index plungers, the knob is pulled-out, turned 90° and secured by a notched catch (when locking pin should not overhang).

More information

Notes

Knob not removable.

Further products

- Retrieval Units, with sensor

Drawing

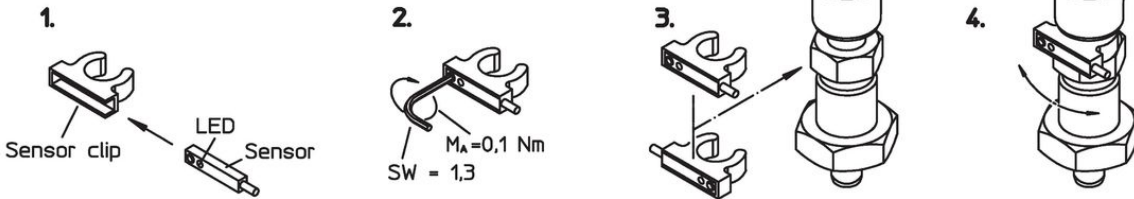
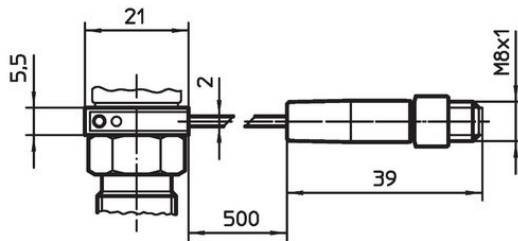
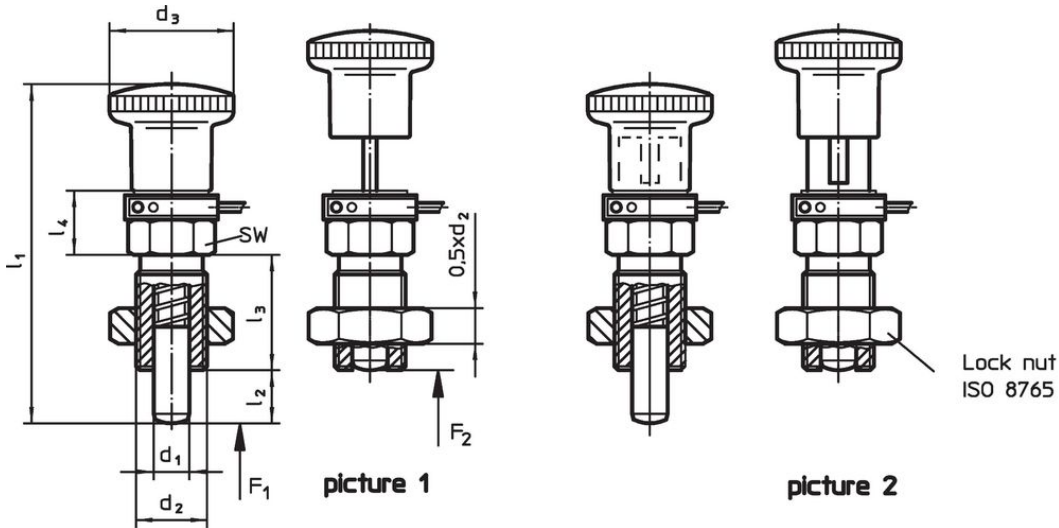

Order information

Dimensions							WS	Spring load ¹⁾		Temperature		Weight	Art. No.
d ₁	d ₂	l ₂ min.	d ₃	l ₁	l ₃	l ₄		F ₁	F ₂	min.	max.		
[mm]							[mm]	[N]		[°C]		[g]	
-0.02 -0.05													
with knob and locking – picture 2													
4	M8 x 1	6	16	41.5	16	11.5	10	4	12.5	-25	75	34	22123.0104

¹⁾ statistical average value

Application example

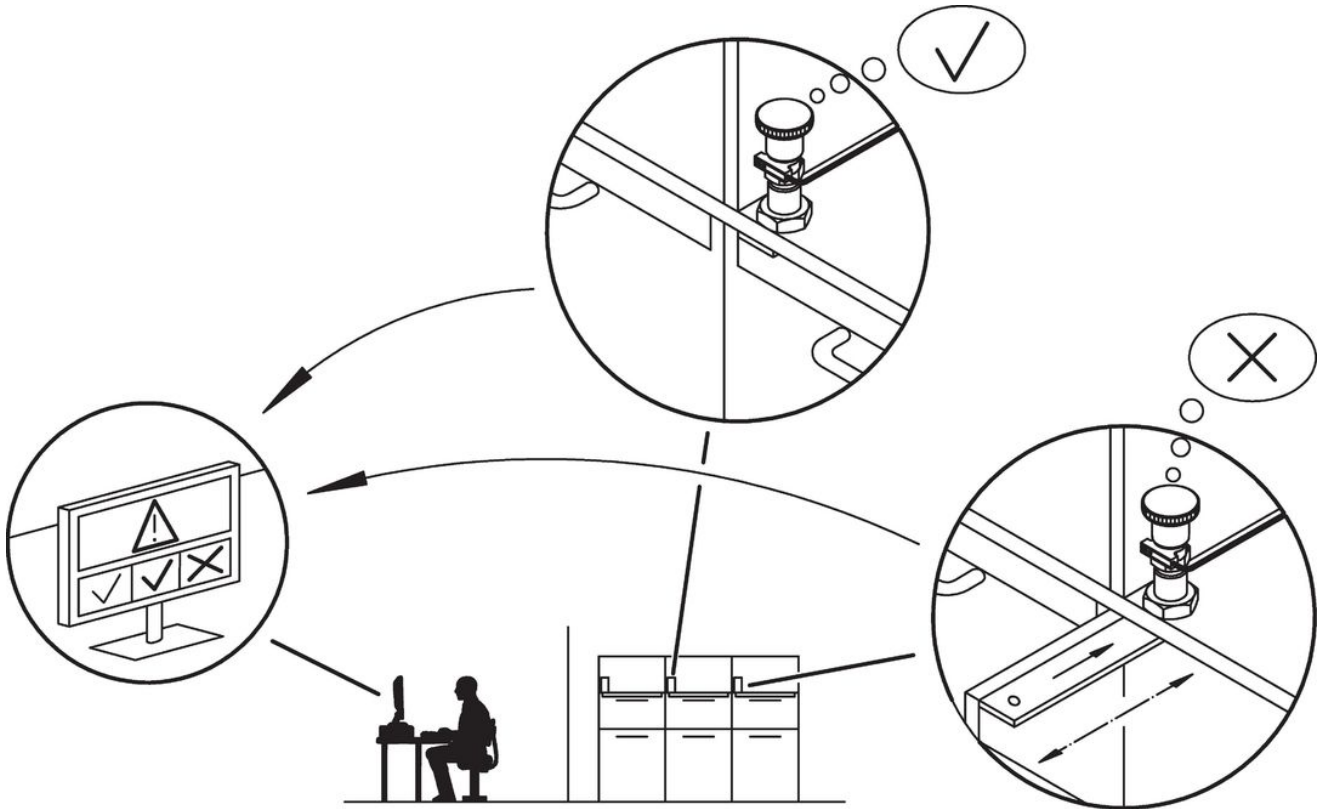

Compliance

RoHS compliant

Compliant according to Directive 2011/65/EU and Directive 2015/863.

Does not contain SVHC substances

No SVHC substances with more than 0.1% w/w contained - SVHC list [REACH] as of 23.01.2024.

Does not contain Proposition 65 substances

No Proposition 65 substances included.

<https://www.P65Warnings.ca.gov/>

Free from Conflict Minerals