

Index Bolts • simple finish

22121.0115



Product Description

Index bolts are used for indexing purposes. Application limited for cases in which no precise positioning is needed. The high stroke of the pin enables for a variety of applications, e.g. as door bolt. Simple version in compact design.

Material

Body

- Free cutting steel, zinc-plated by galvanization

Locking pin

- Steel, zinc-plated by galvanization

Lock nut

- Steel, zinc-plated by galvanization

Operation

By lifting the index bolt the locking pin will be pulled in. The turning of the index bolt positions the pin when it is pulled in.

More information

Notes

Lock nuts have to be purchased separately.

Further products

- Locating Bushings, for index bolts and index plungers

Drawing

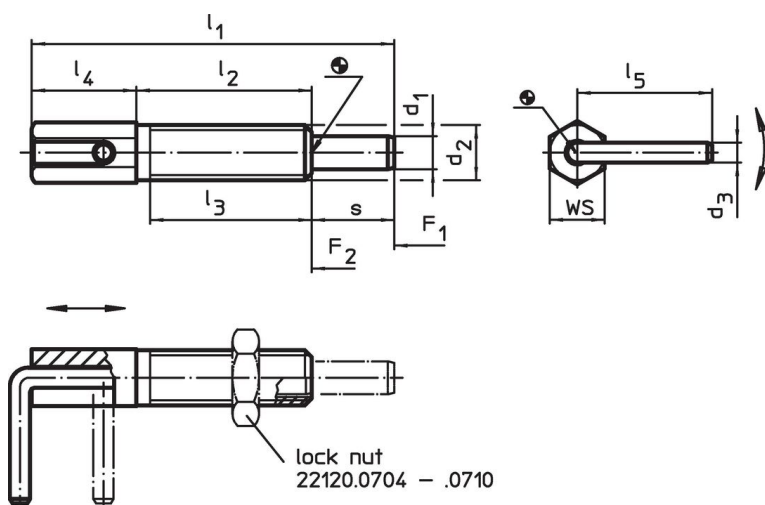



Order information

Dimensions										WS	Spring load ¹⁾		Tightening torque max.	🌡️ max.	🏠 [g]	Art. No.
d ₁	d ₂	d ₃	l ₁	l ₂	l ₃	l ₄	l ₅	s	[mm]		F ₁ ~	F ₂ ~				
6	M10	3.5	65	33.5	30	17.5	22.9	14	10	4	16	10	250	26	22121.0115	

¹⁾ statistical average value

Accessories

	Dimensions d ₂ [mm]	Wrench size [mm]	 [g]	Art. No.
Steel				
	M10	16	5.3	22120.0706

Application example

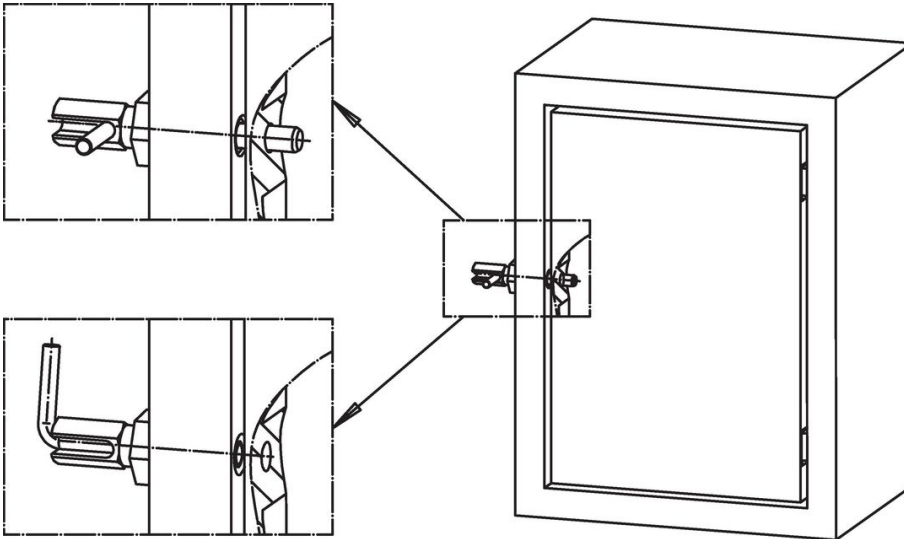

Compliance

RoHS compliant

Contains lead - compliant according to exceptions 6a / 6b / 6c.

Contains SVHC substances >0,1% w/w

Contains lead - SVHC list [REACH] as of 23.01.2024.

Contains Proposition 65 substances



Lead can cause cancer and reproductive harm from exposure
<https://www.P65Warnings.ca.gov/>

Free from Conflict Minerals

This product does not contain any substances designated as "conflict minerals" such as tantalum, tin, gold or tungsten from the Democratic Republic of Congo or adjacent countries.