

Index Plungers • with pull-ring
22120.1344



Product Description

Index plungers are used for indexing bores.

Material

Body

- Steel, blackened

Locking pin

- Stainless steel 1.4305, nickel-plated

Pull-ring

- Stainless steel 1.4310

Assembly

Lock nuts have to be purchased separately.

Operation

When using the model with locking mechanism, you turn the pull-ring by 90° after retracting the locking pin and secure the ring using the notched catch (if the locking pin should not overhang).

More information

Further products

- Mounting Blocks, for index bolts and index plungers, die-cast
- Locating Bushings, for index bolts and index plungers
- Distance Collars, for index plungers
- Mounting Blocks, for index bolts and index plungers

Drawing

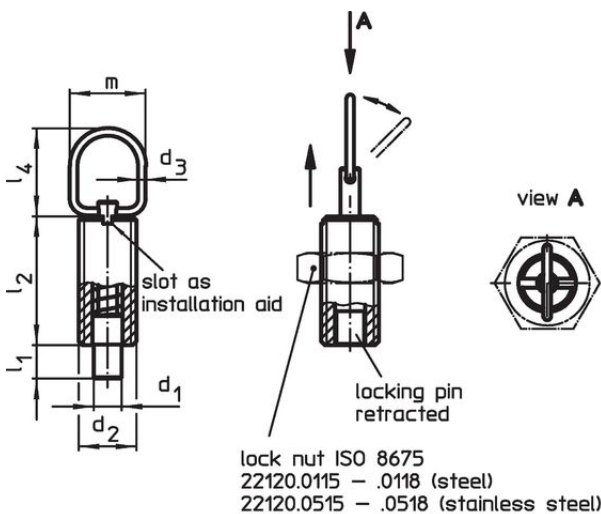

picture 1

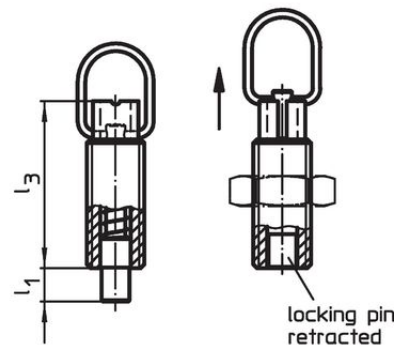

with locking

picture 2

Order information

Dimensions								Stroke s [mm]	Spring load ¹⁾		max. [°C]	[g]	Art. No.
d ₁ -0.05 -0.1	d ₂	d ₃	l ₁ min.	l ₂	l ₃	l ₄	m		F ₁ ~	F ₂ ~			
with locking – picture 2, Steel													
6	M12	2	6	24	31	25	22	6	6	21	250	19	22120.1344

¹⁾ statistical average value

Accessories

	Dimensions d ₂ [mm]	Wrench size [mm]	[g]	Art. No.
Lock nuts ISO 4035, Steel				
	M12	18	7.6	22120.0708

Application example



Compliance

RoHS compliant

Contains lead - compliant according to exceptions 6a / 6b / 6c.

Contains SVHC substances >0,1% w/w

Contains lead - SVHC list [REACH] as of 23.01.2024.

Contains Proposition 65 substances



Lead can cause cancer and reproductive harm from exposure
<https://www.P65Warnings.ca.gov/>

Free from Conflict Minerals

This product does not contain any substances designated as "conflict minerals" such as tantalum, tin, gold or tungsten from the Democratic Republic of Congo or adjacent countries.