

## Index Bolts

### 22120.0367



#### Product Description

Index bolts are used for indexing purposes. Plastic cover for grip allows better handling.

#### Material

##### Body

- Stainless steel 1.4305

##### Locking pin

- Stainless steel 1.4305, nickel-plated

##### Catch

- Dry powdered metal 1.4404

##### Plastic cap

- Thermoplastic, black, dull

#### Operation

By turning the index bolt 180° the locking pin will be pulled-in and secured by a notched catch (when locking pin should not overhang).

#### More information

#### Notes

Lock nuts have to be purchased separately.

#### Further products

- Mounting Blocks, for index bolts and index plungers, die-cast
- Locating Bushings, for index bolts and index plungers
- Mounting Blocks, for index bolts and index plungers

#### Drawing

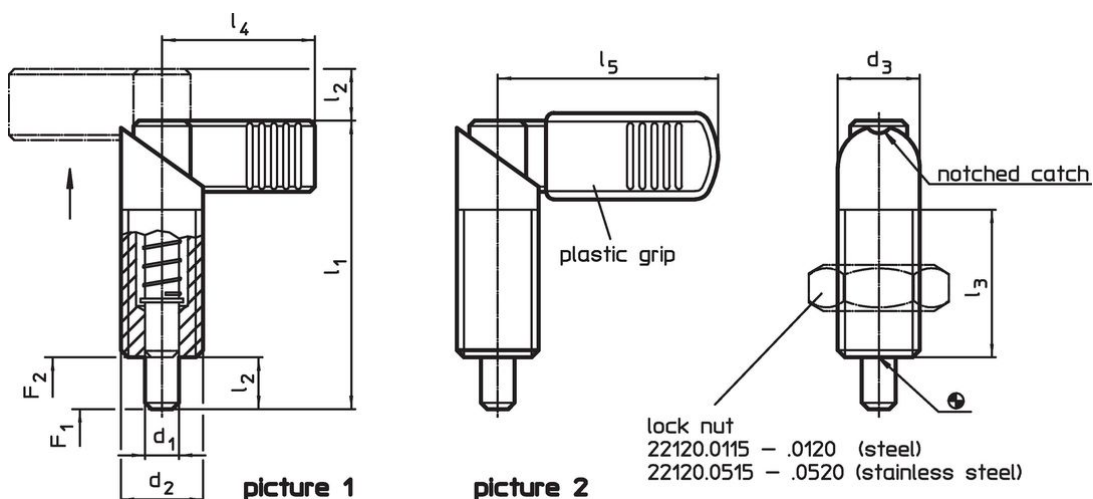



#### Order information

Dimensions							Spring load <sup>1)</sup>		Temperature		Weight [g]	Art. No.	
d <sub>1</sub>	d <sub>2</sub>	d <sub>3</sub>	l <sub>1</sub>	l <sub>2</sub>	l <sub>3</sub>	l <sub>5</sub>	F <sub>1</sub>	F <sub>2</sub>	min.	max.			
-0.02							~	~					
-0.04													
[mm]													
[N]													
[°C]													
with plastic cover for grip – picture 2, Stainless steel													
8	M16 x 1,5	16	56	10	30	42	11.5	30.5	-30	80	63	22120.0367	

<sup>1)</sup> statistical average value

**Accessories**

	Dimensions d <sub>2</sub> [mm]	Wrench size [mm]	 [g]	Art. No.
<b>Lock nuts ISO 8675 (DIN 439), Stainless steel</b>				
	M16 x 1,5	24	15.0	22120.0518

**Compliance**

**RoHS compliant**

Compliant according to Directive 2011/65/EU and Directive 2015/863.

**Does not contain SVHC substances**

No SVHC substances with more than 0.1% w/w contained - SVHC list [REACH] as of 23.01.2024.

**Does not contain Proposition 65 substances**

No Proposition 65 substances included.

<https://www.P65Warnings.ca.gov/>

**Free from Conflict Minerals**

This product does not contain any substances designated as "conflict minerals" such as tantalum, tin, gold or tungsten from the Democratic Republic of Congo or adjacent countries.