

Index Plungers · with locking mechanism push-lock

22111.0010



Product Description

Index plungers are used for indexing bores. These index plungers can be locked or unlocked by pressing the button. This push-lock function is based on the built-in mechanism according to the well-known "biros principle". This design and mode of operation make the index plungers suitable for restricted installation situations. By countersinking the index plunger when locked, it can also be protected against any incorrect operation.

Material

Body

- Steel, blackened

Locking pin

- Steel, nitrided

Knob

- Thermoplastic PA 6, black, dull

Operation

By pressing the button, the locking pin is automatically extended and engaged. Pressing the button again to unlock the locking pin and retract it automatically with spring force.

More information

Notes

Knob not removable.
Lock nuts have to be purchased separately.

Further products

- Locating Bushings, for index bolts and index plungers
- Distance Collars, for index plungers

Drawing

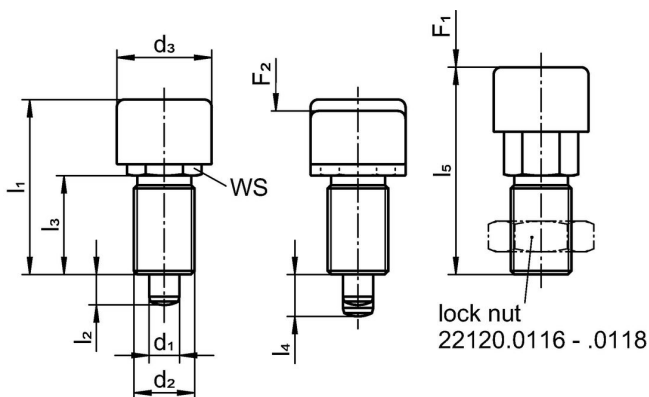



Order information

Dimensions								WS	Spring load ¹⁾		Temperature		Weight	Art. No.
d ₁	d ₂	d ₃	l ₁	l ₂ min.	l ₃	l ₄	l ₅		F ₁	F ₂	min.	max.		
-0.02 -0.05														
[mm]								[mm]	[N]		[°C]		[g]	
6	M12 x 1,5	19	38	6	19.5	9	44.5	13	8.5	25	-30	80	61	22111.0010

¹⁾ statistical average value

Accessories

	Dimensions d ₂ [mm]	Wrench size [mm]	 [g]	Art. No.
Lock nuts ISO 8675 (DIN 439), Steel				
	M12 x 1,5	18	7.5	22120.0116

Compliance

RoHS compliant

Compliant according to Directive 2011/65/EU and Directive 2015/863.

Does not contain SVHC substances

No SVHC substances with more than 0.1% w/w contained - SVHC list [REACH] as of 23.01.2024.

Does not contain Proposition 65 substances

No Proposition 65 substances included.
<https://www.P65Warnings.ca.gov/>

Free from Conflict Minerals

This product does not contain any substances designated as "conflict minerals" such as tantalum, tin, gold or tungsten from the Democratic Republic of Congo or adjacent countries.