

Index Plungers Compact • with hexagon collar and locking, with T-Handle

22110.0832



Product Description

Index plungers are used for indexing bores.
Simple handling, e.g. when using safety gloves, with higher pull release.
Types with / without lock have the same building height.
Due to a thread recess the index plungers can be completely screwed in.

Material

- Body**
- Steel, blackened
- Locking pin**
- Steel, hardened
- Knob**
- Thermoplastic PA 6, black, dull

Assembly

The screw length can be adapted by distance collars for index plungers (EH 22120.).

Operation

The T-Handle is pulled out, turned 90° and secured by an internal notched catch (when locking pin should not overhang). The positions are defined distinctively by the T-Handle.

More information

Notes

Knob not removable.
Lock nuts have to be purchased separately.

Further products

- Mounting Blocks, for index bolts and index plungers, die-cast
- Locating Bushings, for index bolts and index plungers
- Distance Collars, for index plungers

Drawing

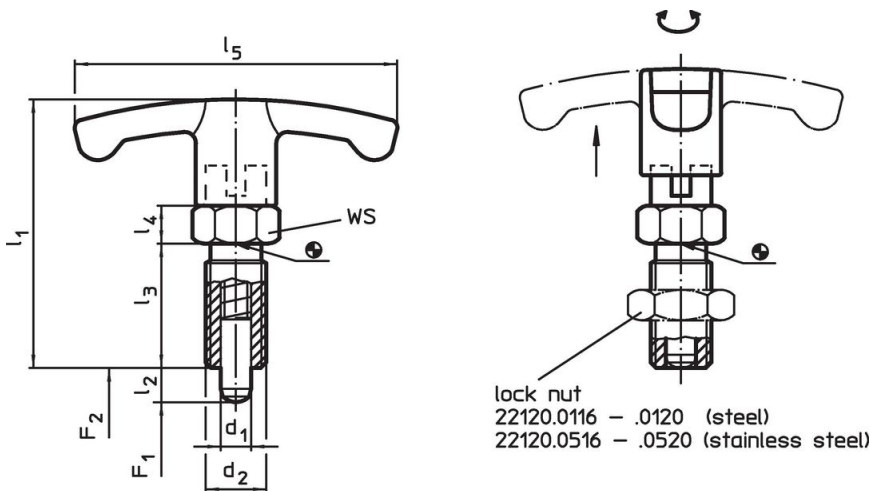



Order information

Dimensions							WS	Spring load ¹⁾		Temperature		Weight	Art. No.
d ₁	l ₂	d ₂	l ₁	l ₃	l ₄	l ₅		F ₁	F ₂	min.	max.	[g]	
[mm]							[mm]	[N]		[°C]			
-0.02 -0.05								~	~				
6	6	M12 x 1,5	48	22	6	54	14	6.5	19	-30	80	33	22110.0832

¹⁾ statistical average value

Accessories

	Dimensions d ₂ [mm]	Wrench size [mm]	 [g]	Art. No.
Lock nuts ISO 8675 (DIN 439), Steel				
	M12 x 1,5	18	7.5	22120.0116

Application example

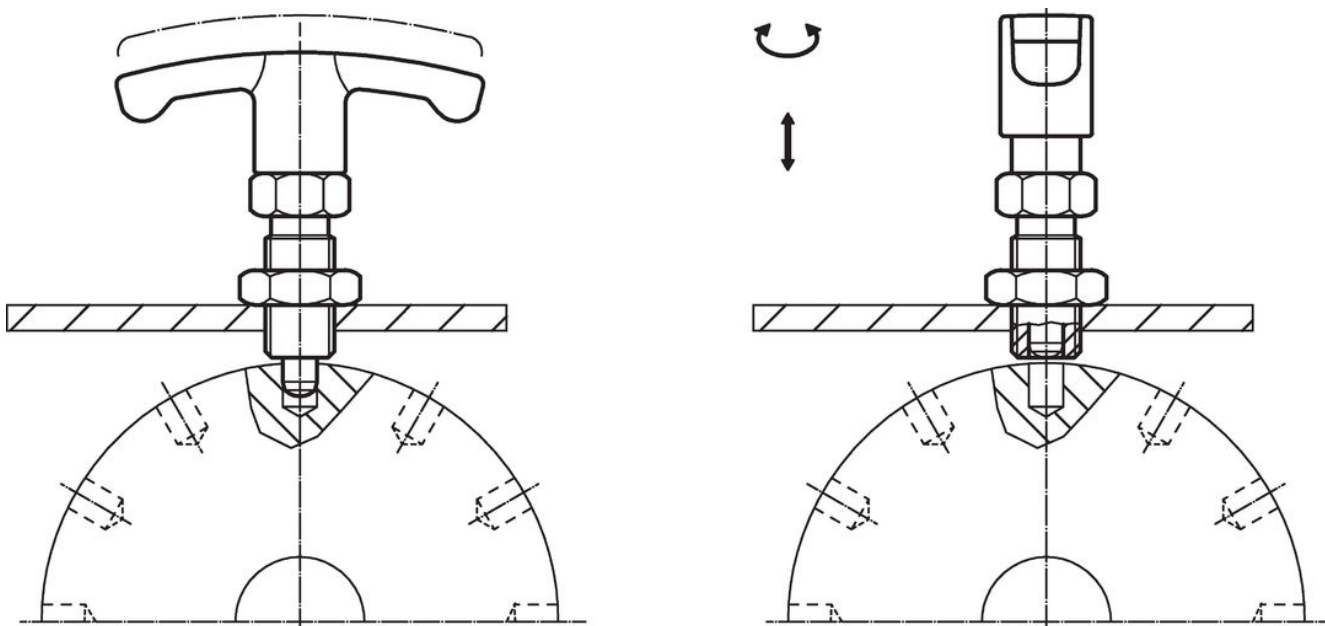

Compliance

RoHS compliant

Contains lead - compliant according to exceptions 6a / 6b / 6c.

Contains SVHC substances >0,1% w/w

Contains lead - SVHC list [REACH] as of 23.01.2024.

Contains Proposition 65 substances



Lead can cause cancer and reproductive harm from exposure
<https://www.P65Warnings.ca.gov/>

Free from Conflict Minerals

This product does not contain any substances designated as "conflict minerals" such as tantalum, tin, gold or tungsten from the Democratic Republic of Congo or adjacent countries.