

Mounting Blocks · for index bolts and index plungers, die-cast

22110.0510



Product Description

Assembly support and extended applications for index bolts and index plungers. Also to be used as a seat for locating bushings EH 22110.

Material

Grub Screw

- Steel, blackened, with brass pad

Body

- Zinc die-cast, plastic coated, black

Assembly

Index plunger must be assembled in hole d_1 on countersink side.

More information

Further products

- Positioning Bushings, for index bolts and index plungers

Drawing

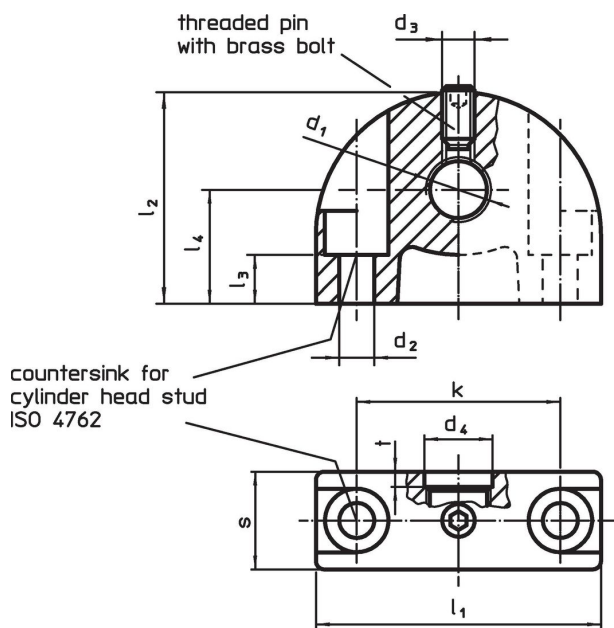

Order information

Dimensions											max. [°C]	[g]	Art. No.		
d_1	d_2	d_3	d_4	k	l_1	l_2	l_3	l_4	s	t					
mounting hole vertical to index bolt and index plunger															
M10	4.3	M4	10.2	25	35	26	6	14	12	2	100	38	22110.0510		

Application example



Compliance

RoHS compliant

Contains lead - compliant according to exceptions 6a / 6b / 6c.

Contains SVHC substances >0,1% w/w

Contains lead - SVHC list [REACH] as of 23.01.2024.

Contains Proposition 65 substances



Lead can cause cancer and reproductive harm from exposure
<https://www.P65Warnings.ca.gov/>

Free from Conflict Minerals

This product does not contain any substances designated as "conflict minerals" such as tantalum, tin, gold or tungsten from the Democratic Republic of Congo or adjacent countries.