

Positioning Bushings • for index bolts and index plungers

22110.0474



Product Description

Positioning bushings are suitable for index plungers and index bolts. Low wear thanks to hardened running ball.

Material

- Stainless steel, hardened

Drawing

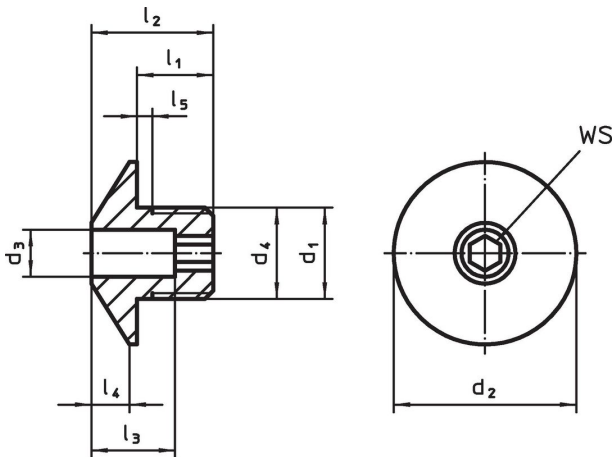

Order information

Dimensions									For pin	WS		Art. No.
d ₁	d ₃ +0.1	d ₂	d ₄ -0.05	l ₁	l ₂	l ₃	l ₄	l ₅ +0.5				
[mm]									[mm]	[mm]	[g]	
Stainless steel												
M12 x 1,5	4.2	24	12	10	16	11	5	1.5	4	4	17	22110.0474

Application example

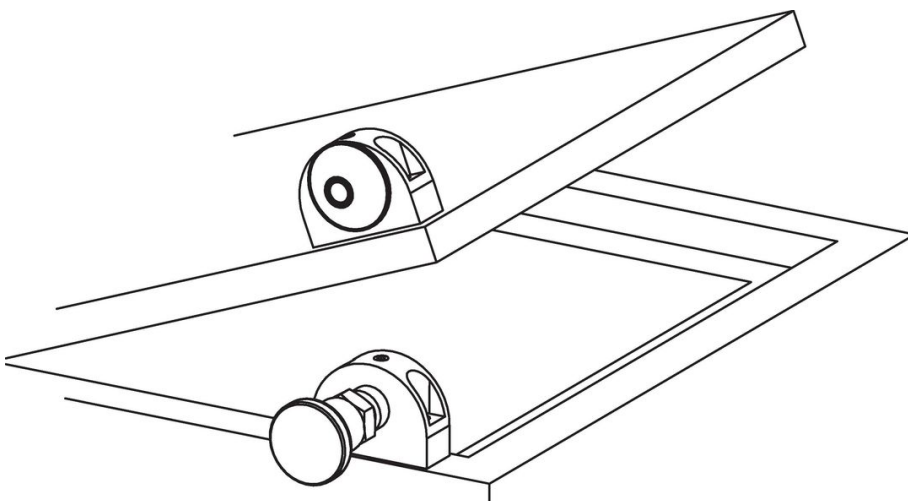

Compliance

RoHS compliant

Compliant according to Directive 2011/65/EU and Directive 2015/863.

Does not contain SVHC substances

No SVHC substances with more than 0.1% w/w contained - SVHC list [REACH] as of 23.01.2024.

Does not contain Proposition 65 substances

No Proposition 65 substances included.

<https://www.P65Warnings.ca.gov/>

Free from Conflict Minerals

This product does not contain any substances designated as "conflict minerals" such as tantalum, tin, gold or tungsten from the Democratic Republic of Congo or adjacent countries.