

## Positioning Bushings • for index bolts and index plungers

22110.0468



### Product Description

Positioning bushings are suitable for index plungers and index bolts. Low wear thanks to hardened running ball.

### Material

- Steel, hardened, blackened

### Drawing

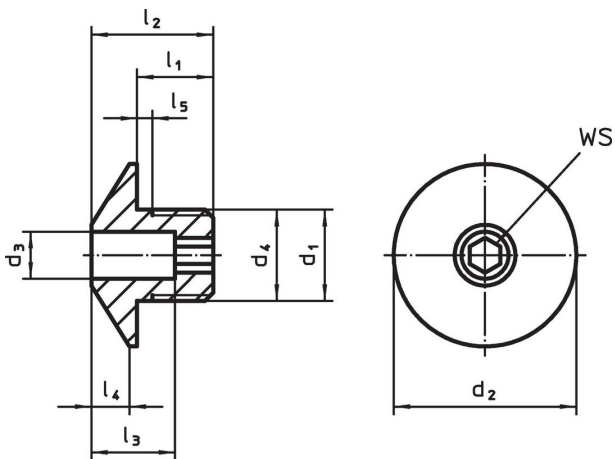

### Order information

Dimensions									For pin	WS	Art. No.	
d <sub>1</sub>	d <sub>3</sub> +0.1	d <sub>2</sub>	d <sub>4</sub> -0.05	l <sub>1</sub>	l <sub>2</sub>	l <sub>3</sub>	l <sub>4</sub>	l <sub>5</sub> +0.5	[mm]	[mm]		[g]
Steel												
M16 x 1,5	8.2	32	16	12	20	13	7	1.5	8	6	36	22110.0468

### Application example

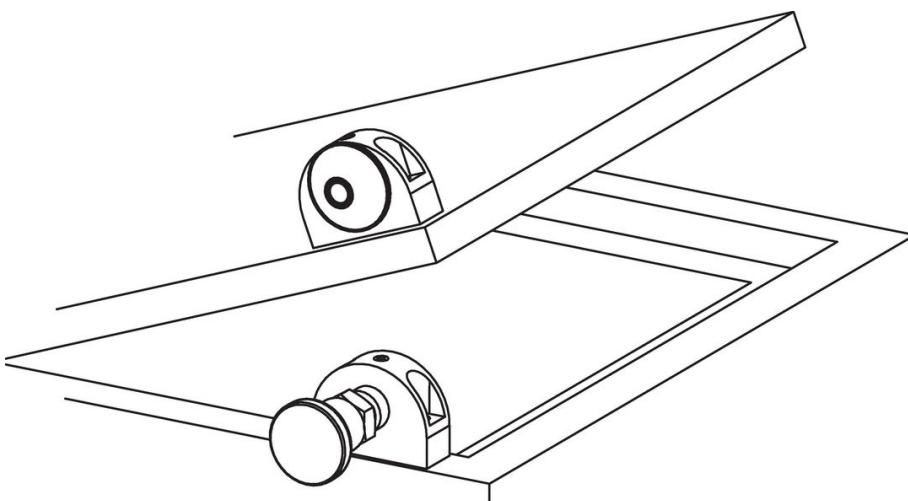

## Compliance

### RoHS compliant

Contains lead - compliant according to exceptions 6a / 6b / 6c.

### Contains SVHC substances >0,1% w/w

Contains lead - SVHC list [REACH] as of 23.01.2024.

### Contains Proposition 65 substances



Lead can cause cancer and reproductive harm from exposure  
<https://www.P65Warnings.ca.gov/>

### Free from Conflict Minerals

This product does not contain any substances designated as "conflict minerals" such as tantalum, tin, gold or tungsten from the Democratic Republic of Congo or adjacent countries.