

Locating Bushings · for index bolts and index plungers

22110.0455



Product Description

Used for locating the locking pin of index bolts and index plungers. Suitable for mounting blocks 22110.0412 and 22110.0416.

Material

- Steel, nitrided

More information

Further products

- Mounting Blocks, for index bolts and index plungers, die-cast

Drawing

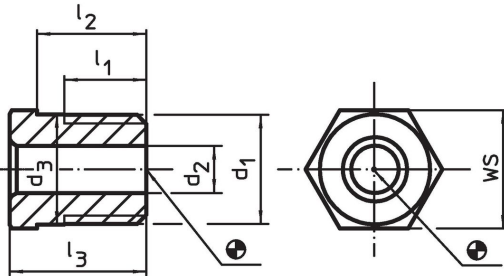

Order information

d ₁	Dimensions					For pin	WS	max. [°C]	[g]	Art. No.
	d ₂ +0.1	d ₃ ±0.3	l ₁ min.	l ₂ -0.3	l ₃					
M12 x 1,5	5.2	12.1	9	10	13	5	13	250	9.6	22110.0455

Application example

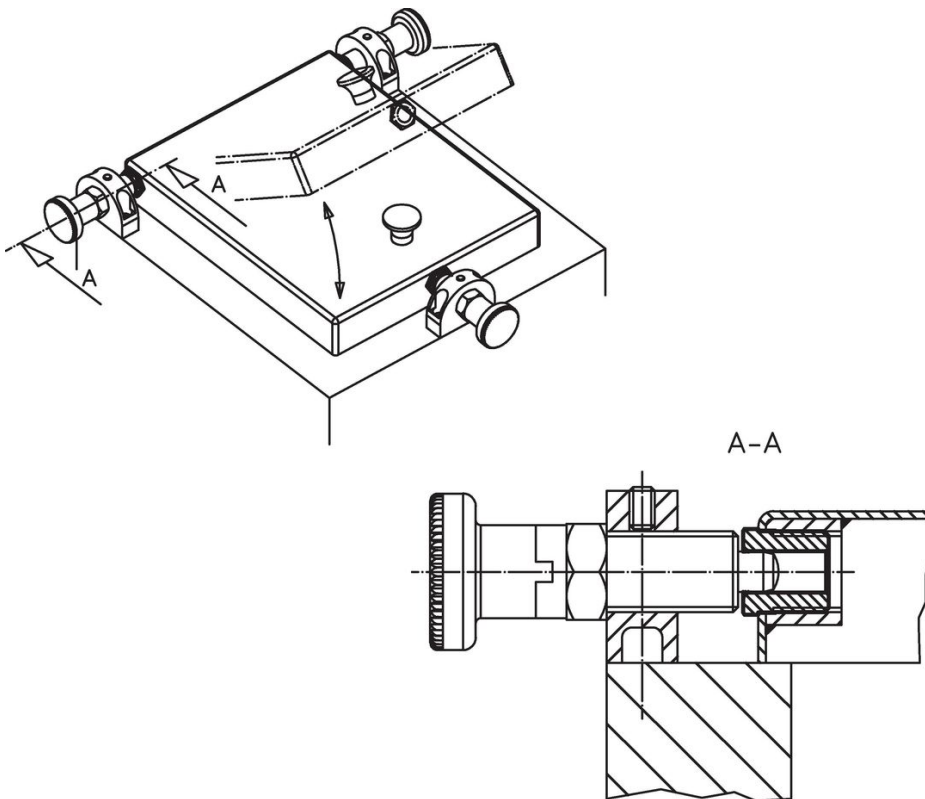

Compliance

RoHS compliant

Contains lead - compliant according to exceptions 6a / 6b / 6c.

Contains SVHC substances >0,1% w/w

Contains lead - SVHC list [REACH] as of 23.01.2024.

Contains Proposition 65 substances



Lead can cause cancer and reproductive harm from exposure
<https://www.P65Warnings.ca.gov/>

Free from Conflict Minerals

This product does not contain any substances designated as "conflict minerals" such as tantalum, tin, gold or tungsten from the Democratic Republic of Congo or adjacent countries.