

Spring Plungers · with collar and ball, front slot

22075.0005



Product Description

Spring plungers can be used for locating or for applying pressure, as a detent or for ejection. This spring plunger is characterised by the collar with front slot. This makes it suitable for applications that require a flat surface when screwed in.

Material

Body

- Free cutting steel, blackened

Ball

- Stainless steel, hardened

Spring

- Stainless steel

More information

Notes

Special types on request.
Spring plungers are specially tested for spring range and forces.

References

Thread lock on request, please refer to appendix - Technical Data -
Calculation of indexing resistance, please refer to appendix - Technical Data -

Further products

- Spring Plungers, smooth, with collar and ball

Drawing

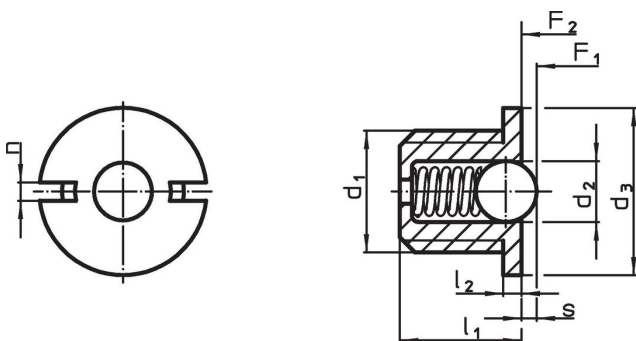

Order information

Dimensions						Stroke s +0.1 -0.1 [mm]	Spring load ¹⁾		max. [°C]	[g]	Art. No.
d ₁	d ₂	d ₃ -0.1	l ₁	l ₂ -0.1	n		F ₁ ~	F ₂ ~			
[mm]							[N]				
body from free cutting steel, ball from stainless steel, standard spring load											
M5	3	7	5	0.8	1.2	0.8	2.9	4.5	250	0.5	22075.0005

¹⁾ statistical average value

Accessories

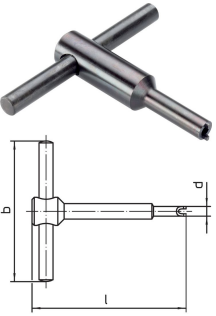
	Dimensions				[g]	Art. No.
	d ₁	b	d	l		
[mm]						
assembly tool						
	M 5	50	6.7	55	24	22075.0905

Application example



Compliance

RoHS compliant

Contains lead - compliant according to exceptions 6a / 6b / 6c.

Contains SVHC substances >0,1% w/w

Contains lead - SVHC list [REACH] as of 23.01.2024.

Contains Proposition 65 substances



Lead can cause cancer and reproductive harm from exposure
<https://www.P65Warnings.ca.gov/>

Free from Conflict Minerals

This product does not contain any substances designated as "conflict minerals" such as tantalum, tin, gold or tungsten from the Democratic Republic of Congo or adjacent countries.