

Locators • smooth, for spring plungers

22020.0040



Product Description

Locators can be used as a counterpart for all spring plungers with ball. They enable the locking, latching and positioning of the respective workpiece. These smooth locators have a 90° countersink. Thanks to the hardened material, the locators are low-wear and particularly suitable for applications with many repeat cycles.

Material

- Steel, hardened, ground

Drawing

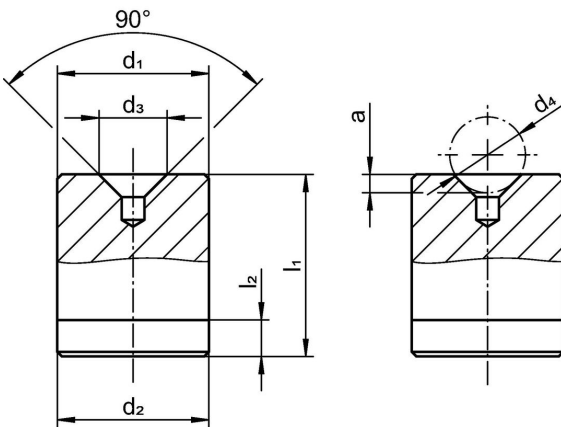

Order information

Dimensions							[g]	Art. No.	
d ₁	d ₂	d ₃	d ₄	a	l ₁	l ₂			
p6	-0.02 -0.08					±0.05			
[mm]									
10	10	4.5	6	1	12	2	7	22020.0040	

Compliance

RoHS compliant

Compliant according to Directive 2011/65/EU and Directive 2015/863.

Does not contain SVHC substances

No SVHC substances with more than 0.1% w/w contained - SVHC list [REACH] as of 23.01.2024.

Does not contain Proposition 65 substances

No Proposition 65 substances included.
<https://www.P65Warnings.ca.gov/>

Free from Conflict Minerals

This product does not contain any substances designated as "conflict minerals" such as tantalum, tin, gold or tungsten from the Democratic Republic of Congo or adjacent countries.