

Connecting Elements • modular, pneumatically operated, protected against twisting

1990.303



Product Description

Material

Body
• Steel, case-hardened, ground

Control module
• Aluminium Al

More information

Further products

- Connecting Rings
- Coverings, for connecting elements

Drawing

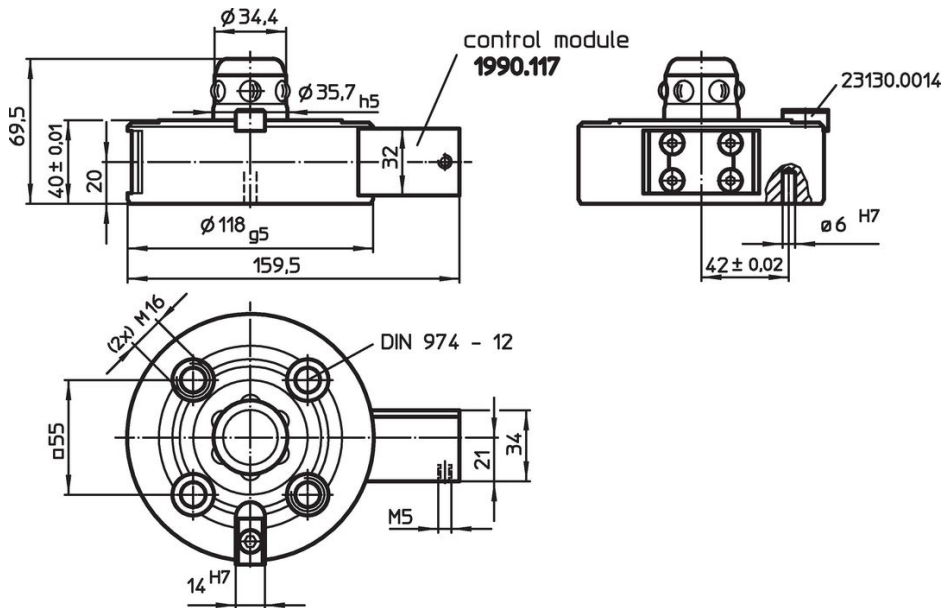

Order information

Holding force	Centering accuracy	Release pressure		Art. No.
[N]	< [mm]	[bar]	[kg]	
5000	0.01	6	3	1990.303

Application example

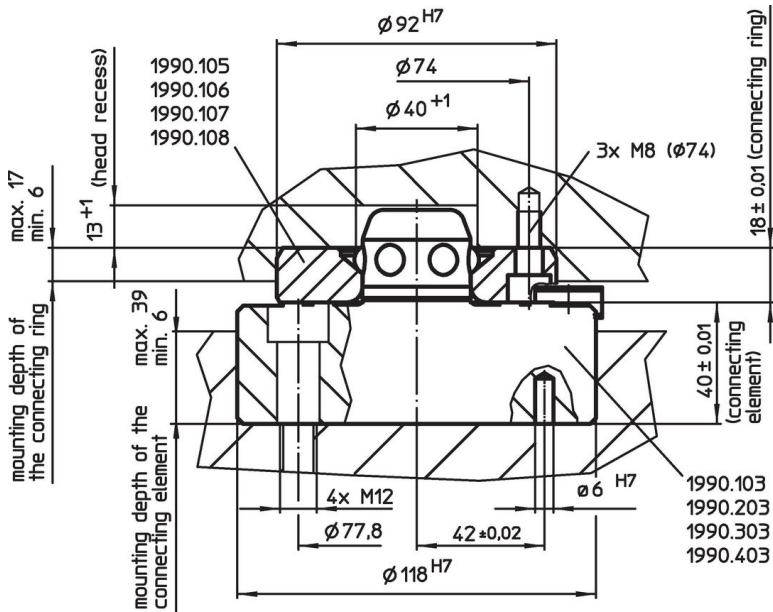

Compliance

RoHS compliant

Compliant according to Directive 2011/65/EU and Directive 2015/863.

Does not contain SVHC substances

No SVHC substances with more than 0.1% w/w contained - SVHC list [REACH] as of 23.01.2024.

Does not contain Proposition 65 substances

No Proposition 65 substances included.

<https://www.P65Warnings.ca.gov/>

Free from Conflict Minerals

This product does not contain any substances designated as "conflict minerals" such as tantalum, tin, gold or tungsten from the Democratic Republic of Congo or adjacent countries.