

Base Plates • for 4 single acting connecting elements

1990.170



Product Description

Material

- Aluminium Al

More information

Notes

Special types on request.

Further products

- Connecting Elements, hydraulically operated, single acting with lifting-off
- Supporting Plates, with 4 connecting rings

Drawing

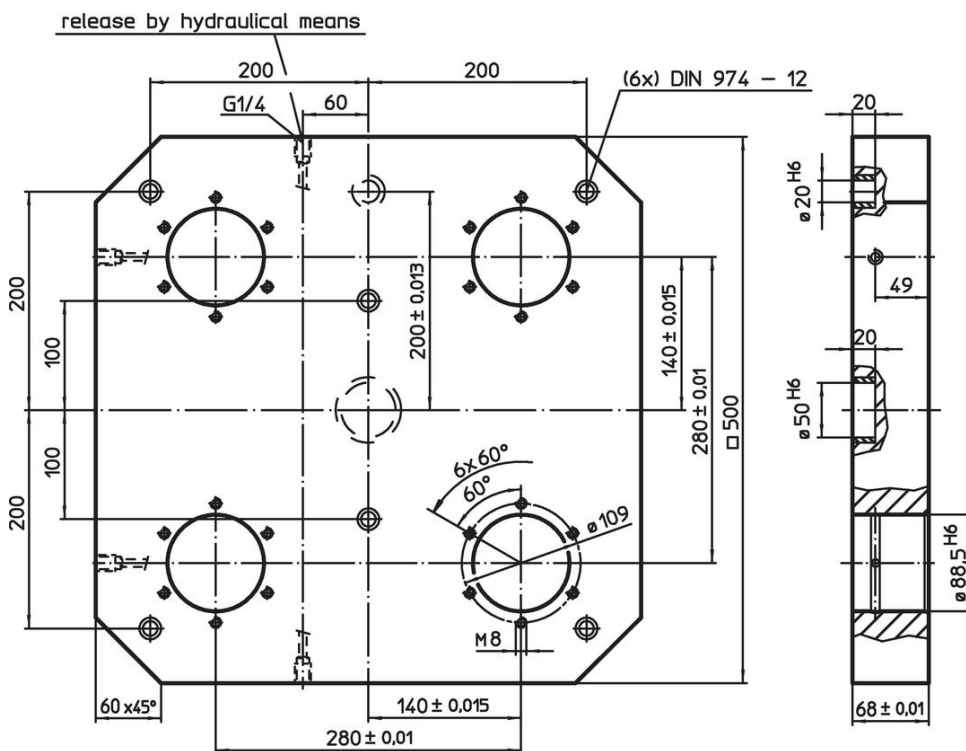

Order information

	Art. No.
<div style="text-align: center;">  [kg] 35 </div>	1990.170

Application example

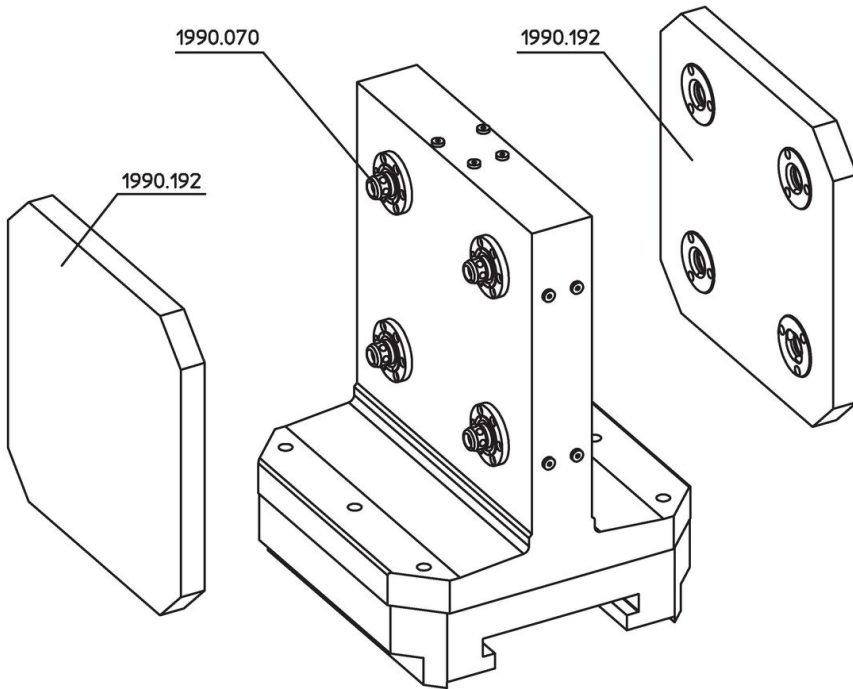

Compliance

RoHS compliant

Contains lead - compliant according to exceptions 6a / 6b / 6c.

Contains SVHC substances >0,1% w/w

Contains lead - SVHC list [REACH] as of 23.01.2024.

Contains Proposition 65 substances



Lead can cause cancer and reproductive harm from exposure
<https://www.P65Warnings.ca.gov/>

Free from Conflict Minerals

This product does not contain any substances designated as "conflict minerals" such as tantalum, tin, gold or tungsten from the Democratic Republic of Congo or adjacent countries.