

Base Plates · with 2 connecting elements

1990.126



Product Description

Material

Connecting element
• Refer to Art. No. 1990.100-102

Base plate
• Aluminium Al

More information

Notes

Special types on request.

Further products

- Connecting Elements, modular, mechanically operated
- Connecting Elements, modular, hydraulically operated
- Connecting Elements, modular, pneumatically operated
- Supporting Plates, with 2 connecting rings

Drawing

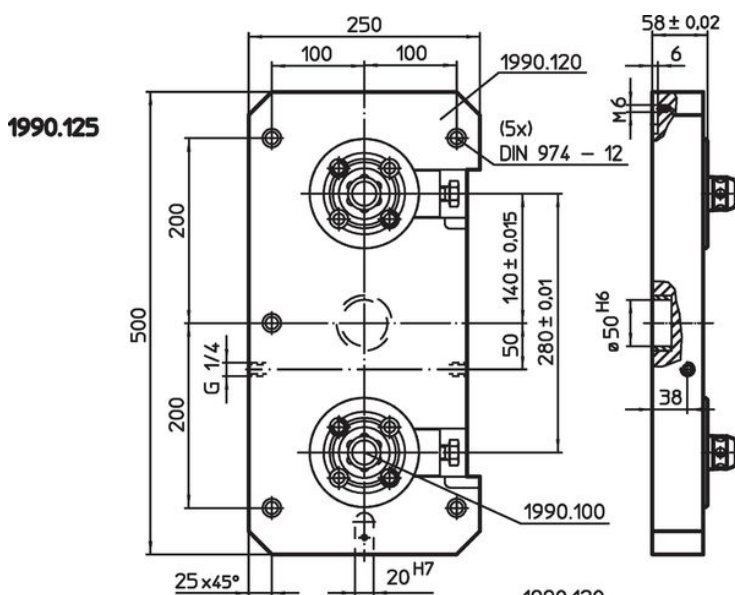

1990.126

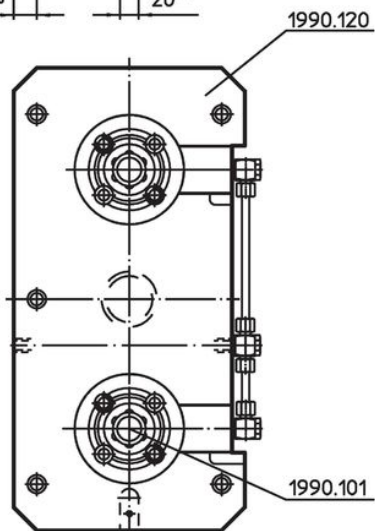

1990.127

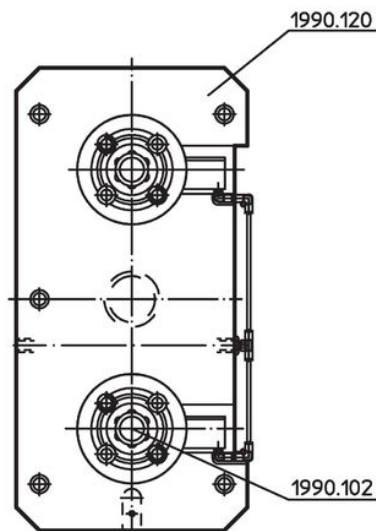

Order information

	 [kg]	Art. No.
hydraulic	17	1990.126

Compliance

RoHS compliant

Contains lead - compliant according to exceptions 6a / 6b / 6c.

Contains SVHC substances >0,1% w/w

Contains lead - SVHC list [REACH] as of 27.06.2024.

Contains Proposition 65 substances



Lead can cause cancer and reproductive harm from exposure
<https://www.P65Warnings.ca.gov/>

Free from Conflict Minerals

This product does not contain any substances designated as "conflict minerals" such as tantalum, tin, gold or tungsten from the Democratic Republic of Congo or adjacent countries.