

## Base Plates · with positioning holes

1912.320



### Product Description

#### Material

- Grey cast iron GG

#### More information

#### Notes

Special plates on request.

### Drawing

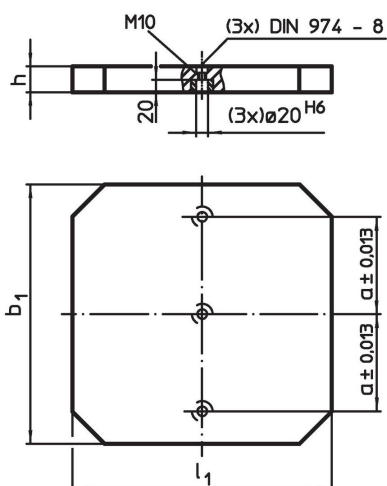

### Order information

b <sub>1</sub> x l <sub>1</sub>	Dimensions			[kg]	Art. No.
	[mm]	h ±0.02	a ±0.013		
400 x 500		40	150	57	1912.320

### Application example

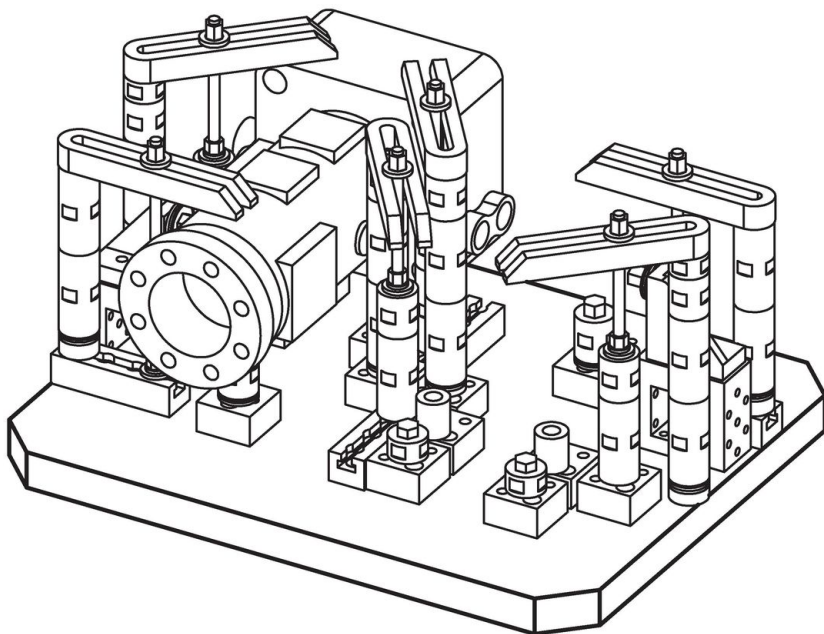

## Compliance

### RoHS compliant

Compliant according to Directive 2011/65/EU and Directive 2015/863.

### Does not contain SVHC substances

No SVHC substances with more than 0.1% w/w contained - SVHC list [REACH] as of 27.06.2024.

### Does not contain Proposition 65 substances

No Proposition 65 substances included.

<https://www.P65Warnings.ca.gov/>

### Free from Conflict Minerals

This product does not contain any substances designated as "conflict minerals" such as tantalum, tin, gold or tungsten from the Democratic Republic of Congo or adjacent countries.