

## Insertable Plates

1704.510



### Product Description

- Three support heights
- For levelling the workpiece on the five-sided machining jaws
- Ground to high accuracy
- Supplied **without** M 6 x 8 mm mounting screws (Art. No. 1704.600)
- This product is supplied as a pair

### Material

- Steel, hardened

### Drawing

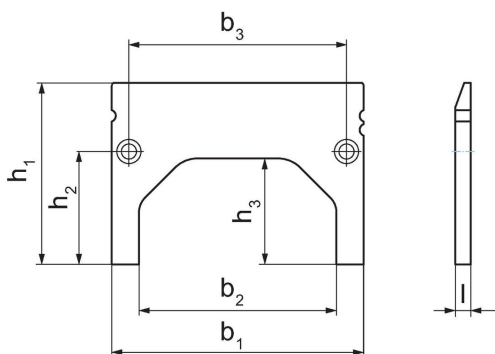

### Order information

b <sub>1</sub>	b <sub>2</sub>	b <sub>3</sub>	Dimensions				[g]	Art. No.
			l	h <sub>1</sub>	h <sub>2</sub>	h <sub>3</sub>		
			[mm]					
125	98	108	7.6	85	56	53	343	1704.510

### Compliance

#### RoHS compliant

Compliant according to Directive 2011/65/EU and Directive 2015/863.

#### Does not contain SVHC substances

No SVHC substances with more than 0.1% w/w contained - SVHC list [REACH] as of 23.01.2024.

#### Does not contain Proposition 65 substances

No Proposition 65 substances included.

<https://www.P65Warnings.ca.gov/>

#### Free from Conflict Minerals

This product does not contain any substances designated as "conflict minerals" such as tantalum, tin, gold or tungsten from the Democratic Republic of Congo or adjacent countries.