

Stops • diamond coated
1586.010



Product Description

Material

- Pin**
- Diamond coating
- Body**
- Tool steel, hardened

Drawing

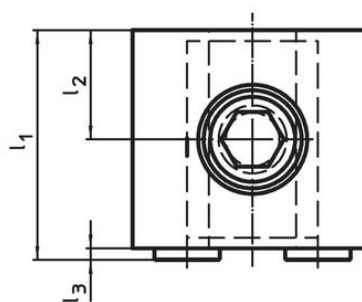
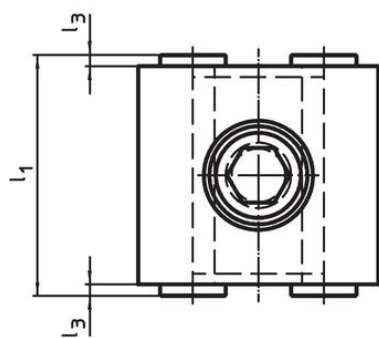
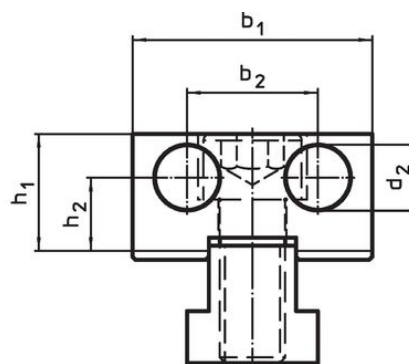
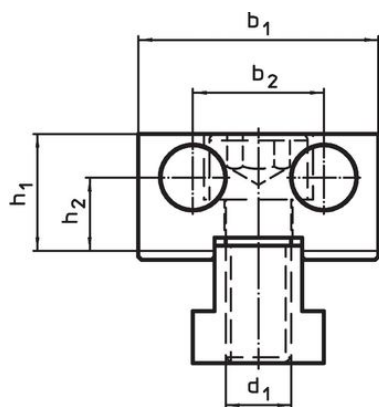

picture 1

picture 2

Order information

Dimensions								[g]	Art. No.
d ₁	d ₂	l ₁	l ₃	b ₁ -0.05 [mm]	b ₂	h ₁	h ₂		
diamond coated, two-sided – picture 1									
M12	12	44	2	44	24	21.4	13.4	406	1586.010

Compliance

RoHS compliant

Compliant according to Directive 2011/65/EU and Directive 2015/863.

Does not contain SVHC substances

No SVHC substances with more than 0.1% w/w contained - SVHC list [REACH] as of 23.01.2024.

Does not contain Proposition 65 substances

No Proposition 65 substances included.

<https://www.P65Warnings.ca.gov/>

Free from Conflict Minerals

This product does not contain any substances designated as "conflict minerals" such as tantalum, tin, gold or tungsten from the Democratic Republic of Congo or adjacent countries.