

Positioning Clamping Cylinders

1553.500



Product Description

Material

- Steel, case-hardened, ground

Drawing



Order information

System	Dimensions						[g]	Art. No.
	h_1 ± 0.01	h_2	d	d_1	d_2	h_3		
L12	25	36	40	12	54	24	502	1553.500

Application example

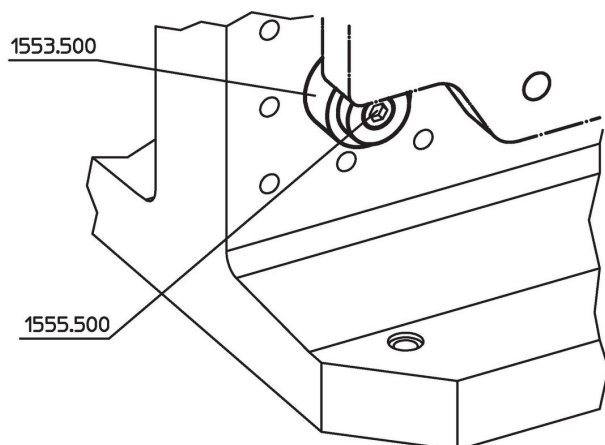

Compliance

RoHS compliant

Compliant according to Directive 2011/65/EU and Directive 2015/863.

Does not contain SVHC substances

No SVHC substances with more than 0.1% w/w contained - SVHC list [REACH] as of 23.01.2024.

Does not contain Proposition 65 substances

No Proposition 65 substances included.

<https://www.P65Warnings.ca.gov/>

Free from Conflict Minerals

This product does not contain any substances designated as "conflict minerals" such as tantalum, tin, gold or tungsten from the Democratic Republic of Congo or adjacent countries.