

Support Clamping Bars

1114.100



Product Description

Material

- Steel, case-hardened, ground

Drawing

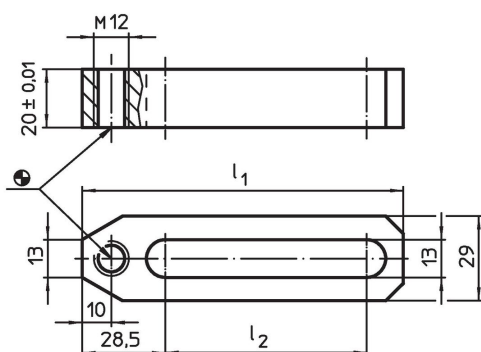

Order information

System	Dimensions		[g]	Art. No.
	l_1	l_2		
V70/L12	150	109	422	1114.100

Compliance

RoHS compliant

Compliant according to Directive 2011/65/EU and Directive 2015/863.

Does not contain SVHC substances

No SVHC substances with more than 0.1% w/w contained - SVHC list [REACH] as of 27.06.2024.

Does not contain Proposition 65 substances

No Proposition 65 substances included.

<https://www.P65Warnings.ca.gov/>

Free from Conflict Minerals

This product does not contain any substances designated as "conflict minerals" such as tantalum, tin, gold or tungsten from the Democratic Republic of Congo or adjacent countries.