

## T-Slot Centering Blocks

1029.600



### Product Description

#### Material

- Steel, case-hardened, ground

### Drawing

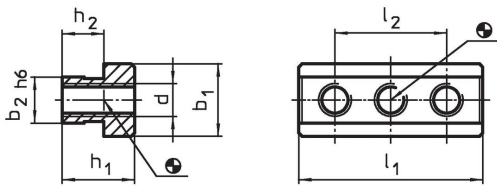

### Order information

System	Dimensions							[g]	Art. No.
	$h_1$	$h_2$	$b_1$	$b_2$	$d$	$l_1$	$l_2$		
V40	13.5	8.5	15	10	M6	38	26	41	1029.600

### Application example

**1863.9063** M6x16 UFK-10.9 (V40)

**1863.8025** M10x25 UFK-10.9 (V70)

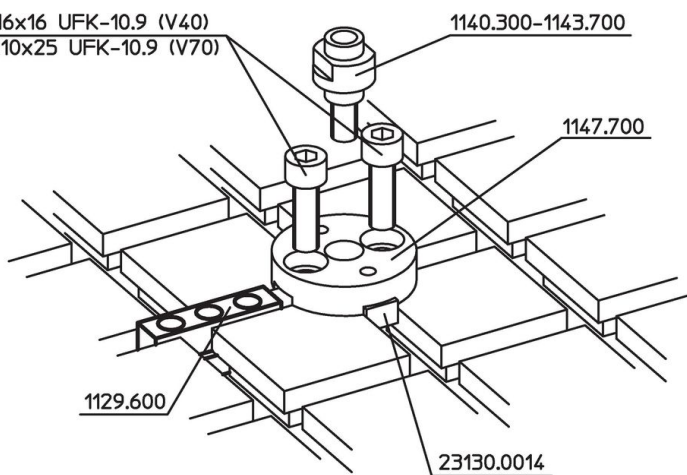

## Compliance

### RoHS compliant

Compliant according to Directive 2011/65/EU and Directive 2015/863.

### Does not contain SVHC substances

No SVHC substances with more than 0.1% w/w contained - SVHC list [REACH] as of 27.06.2024.

### Does not contain Proposition 65 substances

No Proposition 65 substances included.

<https://www.P65Warnings.ca.gov/>

### Free from Conflict Minerals

This product does not contain any substances designated as "conflict minerals" such as tantalum, tin, gold or tungsten from the Democratic Republic of Congo or adjacent countries.